

18R ENGINE SERVICE

| | Page |
|---|-------------|
| CUTAWAY VIEW | 4-2 |
| CYLINDER HEAD | |
| Includes: Cylinder Head, Valve and Spring Rocker Arm, Camshaft, Manifold | |
| DISASSEMBLY | 4-4 |
| INSPECTION & REPAIR | 4-8 |
| ASSEMBLY..... | 4-17 |
| TIMING GEAR | |
| Includes: Timing Gear, Chain, Damper and Slipper Pump Drive Shaft and Bearing, Front Oil Seal | |
| DISASSEMBLY | 4-22 |
| INSPECTION & REPAIR | 4-24 |
| ASSEMBLY | 4-29 |
| CYLINDER BLOCK | |
| Includes: Cylinder Block, Piston and Connecting Rod Piston Ring Crank pin and Bearing, Crankshaft and Bearing Flywheel, Rear Oil Seal Input Shaft Bearing | |
| DISASSEMBLY | 4-34 |
| INSPECTION & REPAIR | 4-37 |
| ASSEMBLY..... | 4-47 |

CUTAWAY VIEW

Fig. 4-1

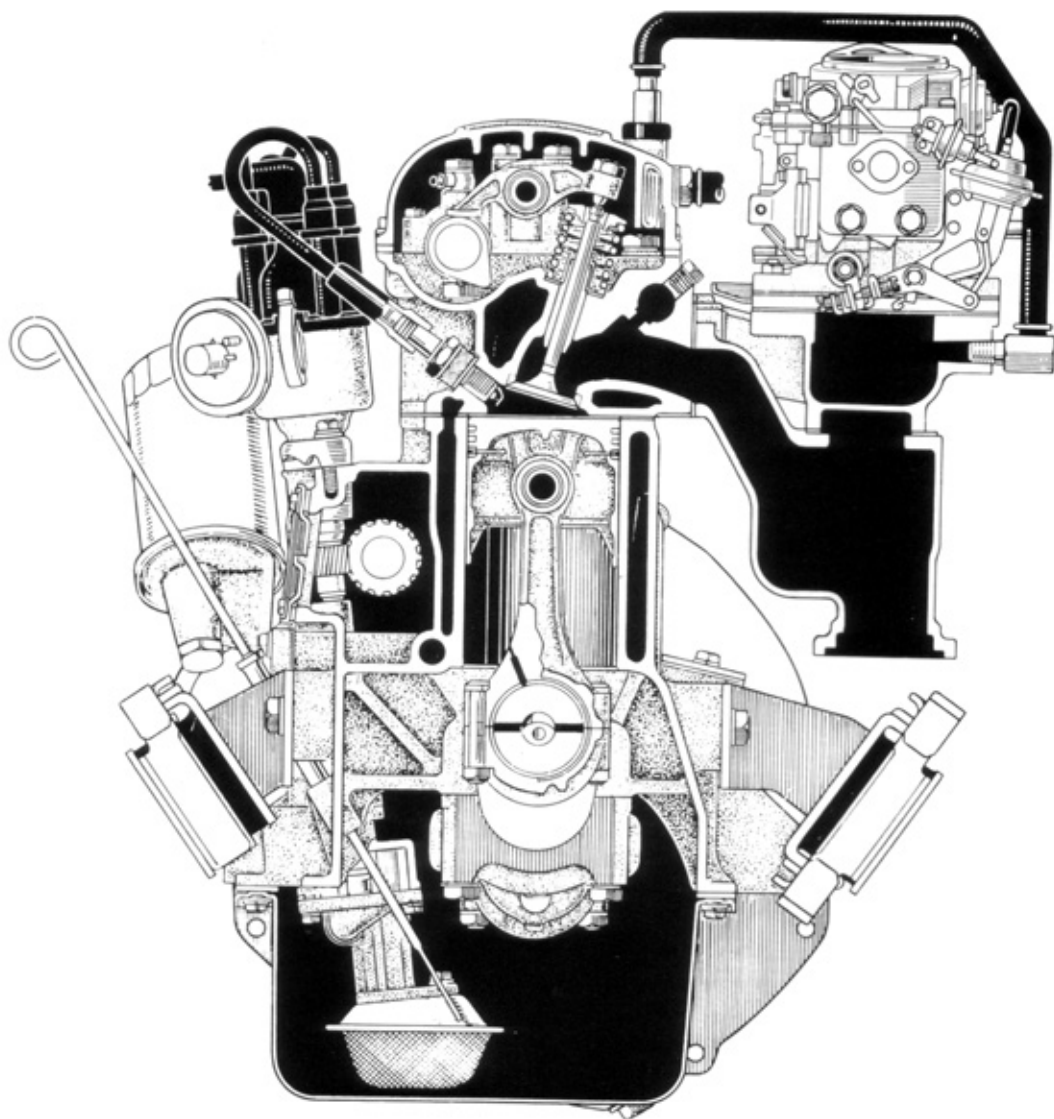
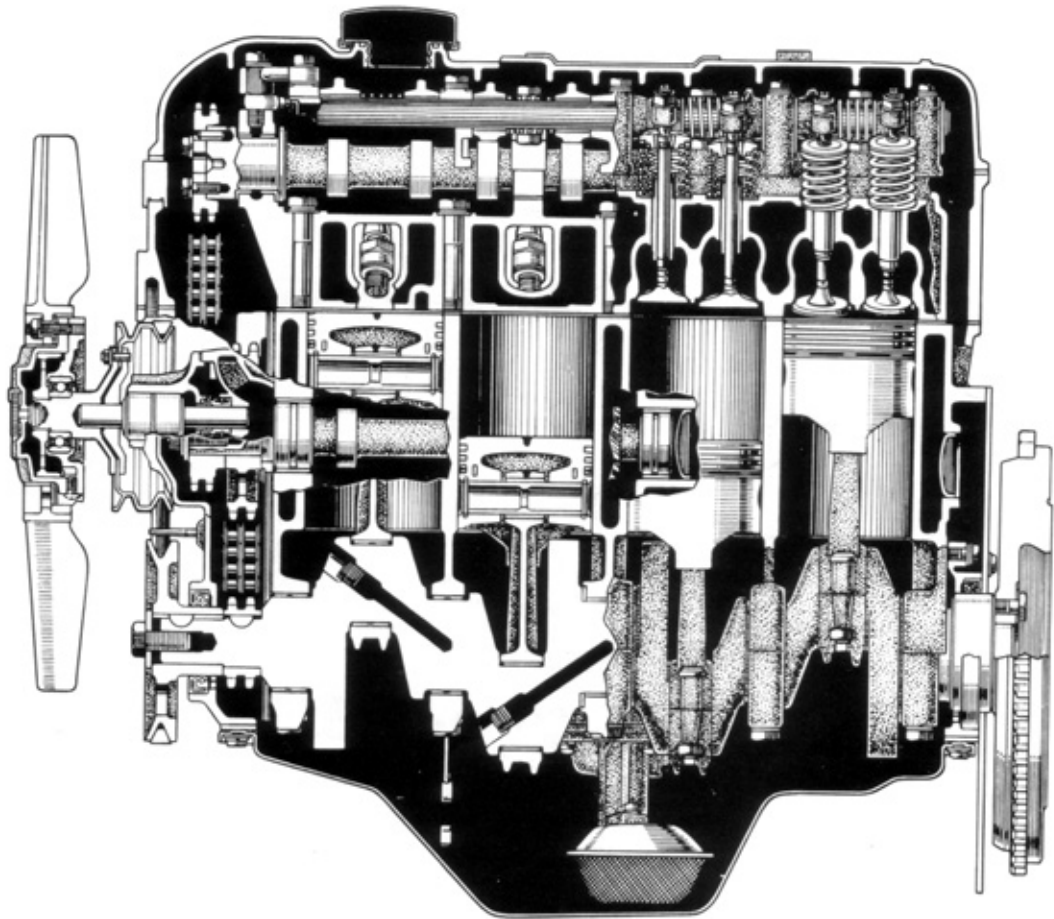

Fig. 4-2



CYLINDER HEAD DISASSEMBLY

Disassemble in numerical order.

Fig. 4-3

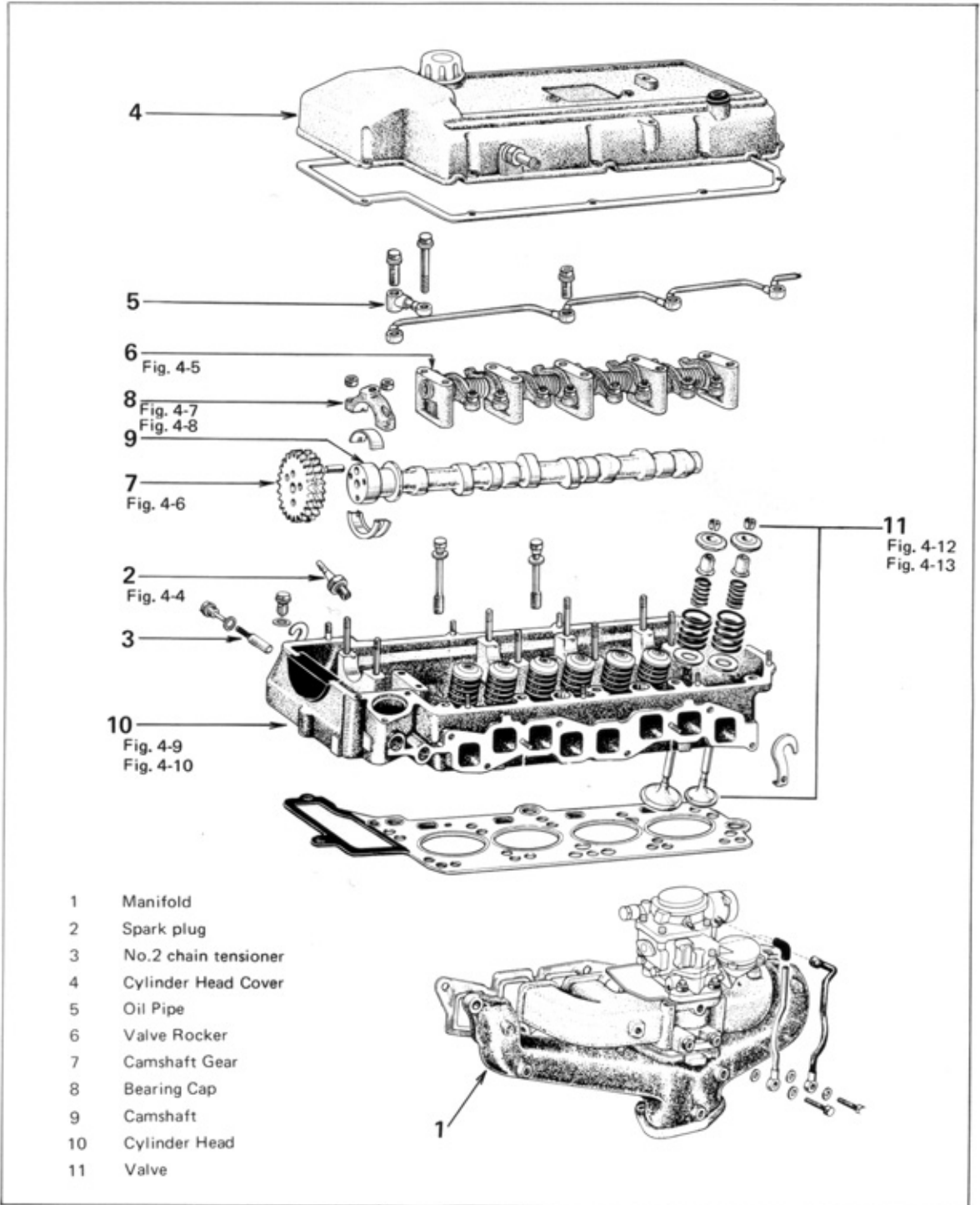
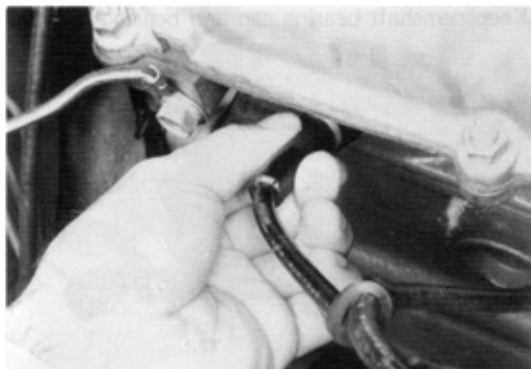
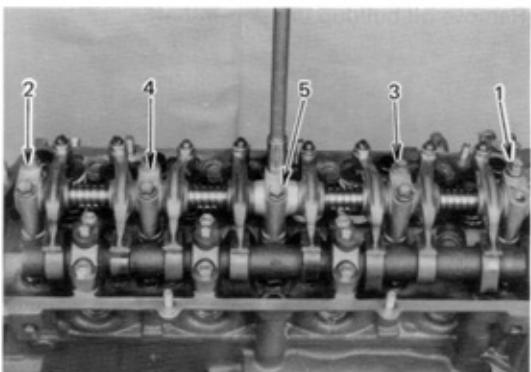

Fig. 4-4



Remove carefully plug cords by pulling rubber boot.

Fig. 4-5



Gradually loosen rocker support bolts in 2 to 3 stages in the sequence as shown.

Fig. 4-6

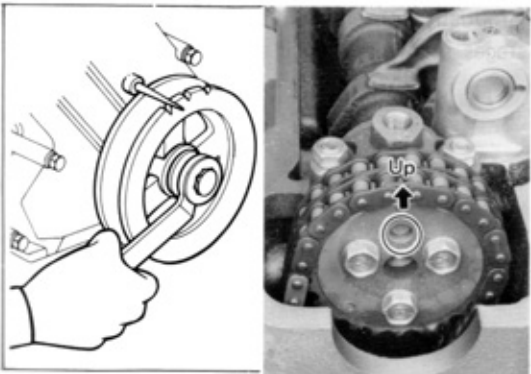

Set No. 1 cylinder to TDC/compression. Camshaft knock pin should point up.

Fig. 4-7

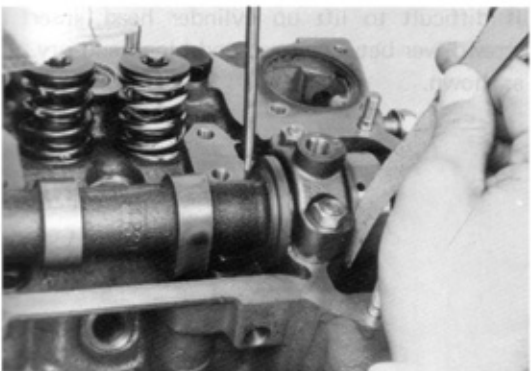

Measure camshaft thrust clearance.

Thrust clearance limit **0.25 mm**
(0.0098 in)

Fig. 4-8

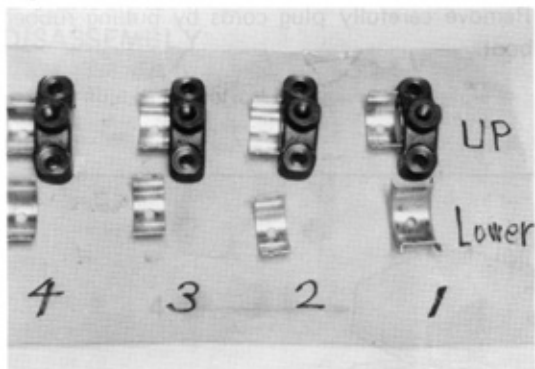

Keep camshaft bearing cap and bearing in order.

Fig. 4-9

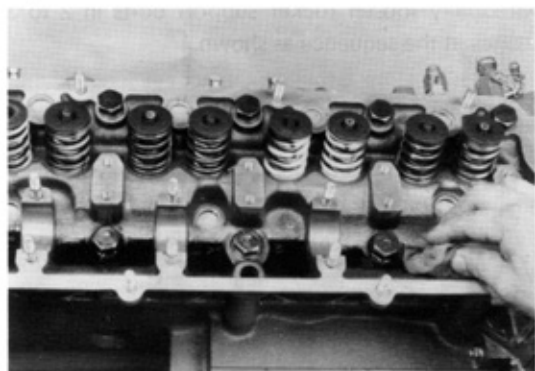

Remove oil buildup under camshaft.

Fig. 4-10

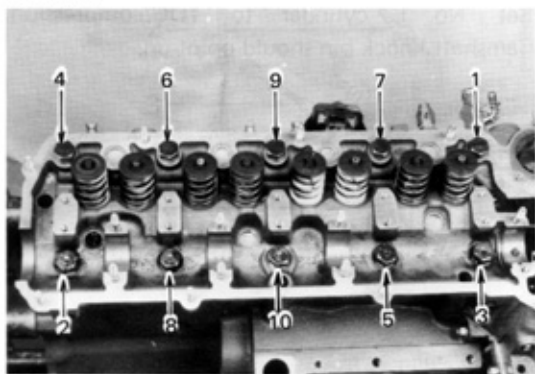

Gradually loosen cylinder head bolts in 2 to 3 stages in the sequence as shown.

Fig. 4-11

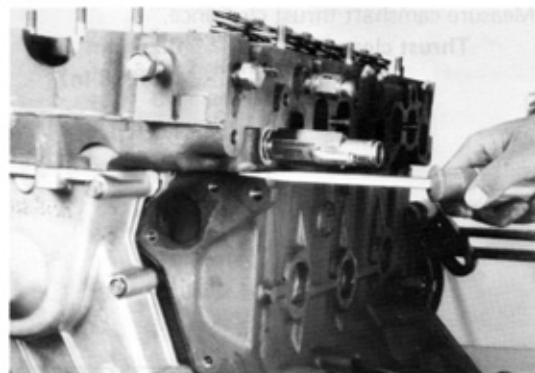

If difficult to lift up cylinder head, insert a screwdriver between head and block and pry off as shown.

Fig. 4-12

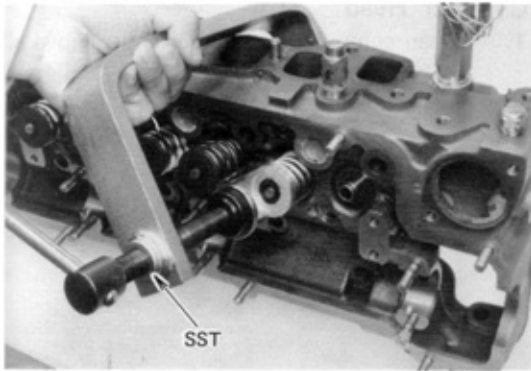

Compress the valve spring with SST [09202-43011].

Fig. 4-13

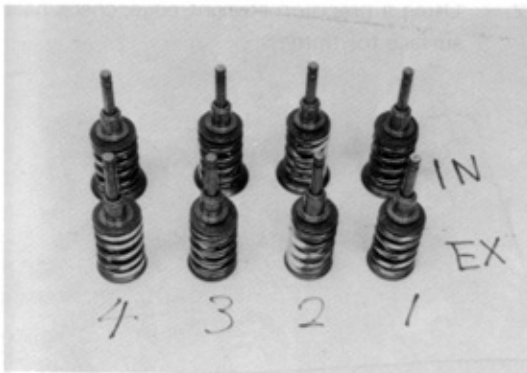

Keep valve and oil seal in order.

Fig. 4-15

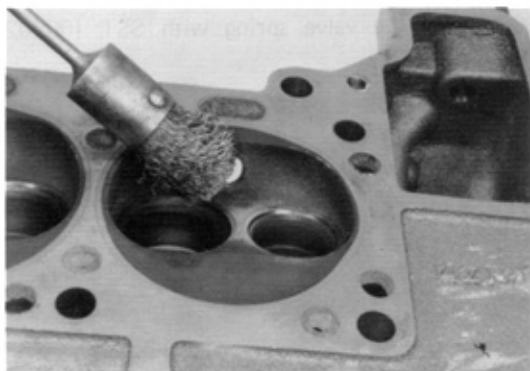

Fig. 4-16

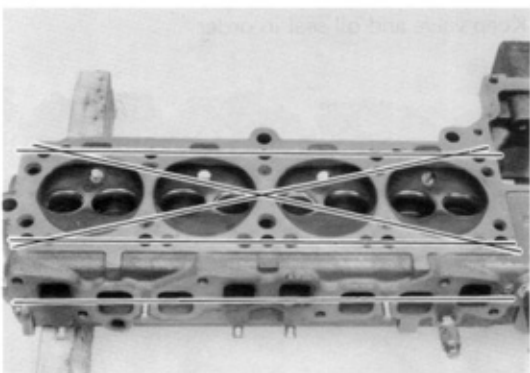

Fig. 4-17

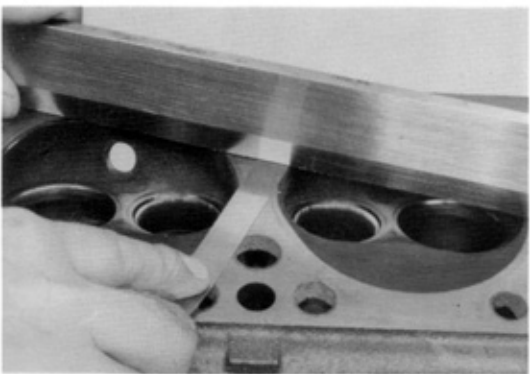
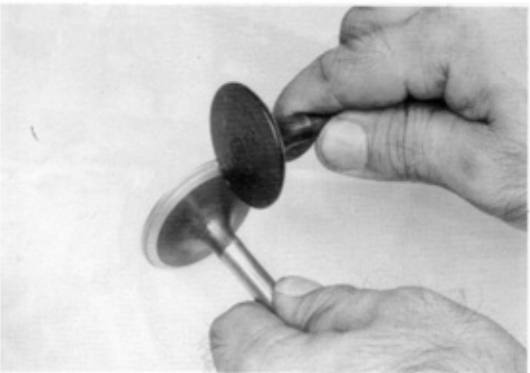

Fig. 4-18



INSPECTION & REPAIR

Cylinder Head



1. Clean combustion chamber and remove all gasket material from manifold and head surface.



2. Using a precision straight edge, check head surface for flatness.



3. If warpage exceeds limit,, correct by machining or replace head.

Head surface warpage limit
0.05 mm (0.0019 in)

Maximum reface limit
0.2 mm (0.0079 in)



Valve, Guide and Seat

1. Clean valves.

Fig. 4-19

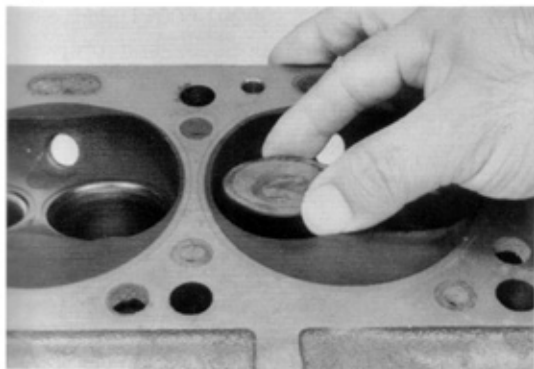

2. Quick-check valve stem and guide wear by inserting correct valve in guide and moving valve as shown.

Fig. 4-20



3. Measure valve stem oil clearance
(1) Measure inside diameter of valve guide.

Fig. 4-21

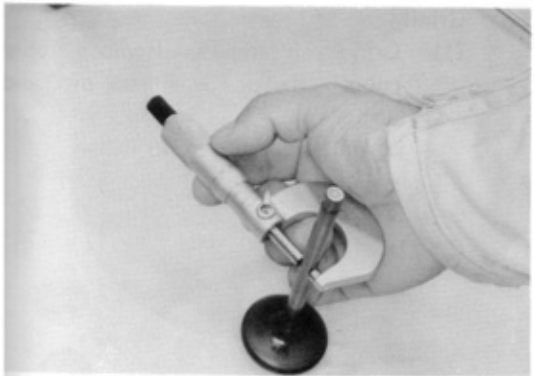

- (2) Measure valve stem diameter.
(3) Subtract stem measurement.

Clearance limit

| | | |
|----------------|----------------|------------------|
| Intake | 0.08 mm | 0.0032 in |
| Exhaust | 0.10 mm | 0.0039 in |

Replace guide and valve if clearance exceeds limit.

Fig. 4-22

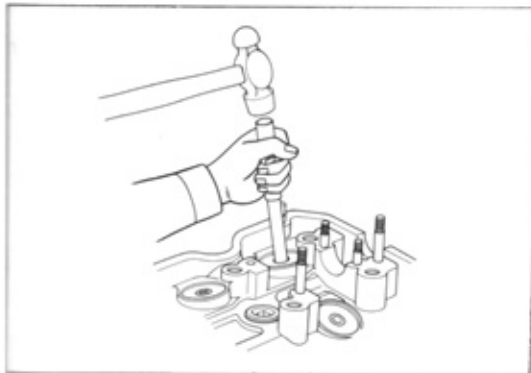

4. Replace guide
(1) Drive out guide from the top end toward the combustion chamber, use SST [09201-60011].

Fig. 4-23

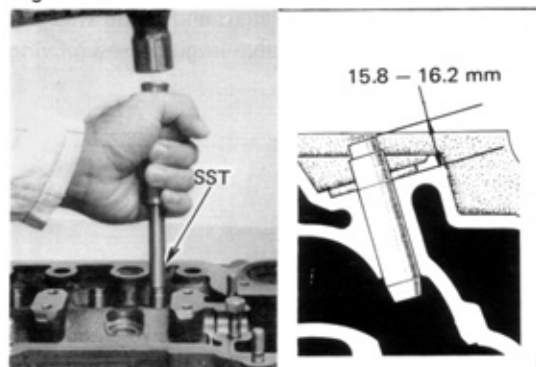

- (2) Using SST [09201-60011], drive in new guide until its end projects from cylinder head the distance noted below.

Projection distance

15.8–16.2 mm
(0.622–0.638 in)

Fig. 4-24

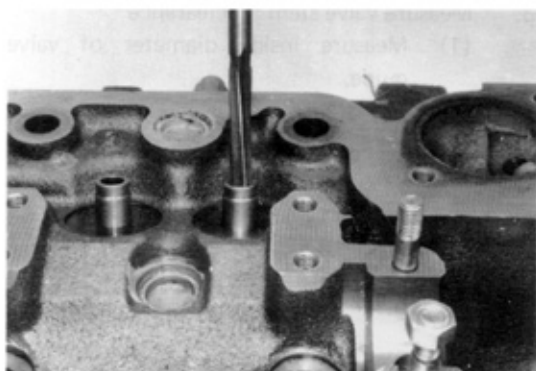

- (3) Using a sharp 8 mm reamer, ream guide to obtain specified clearance.

Intake 0.03–0.06 mm
(0.0012–0.0024 in)

Exhaust 0.04–0.08 mm
(0.0016–0.0032 in)

Fig. 4-25

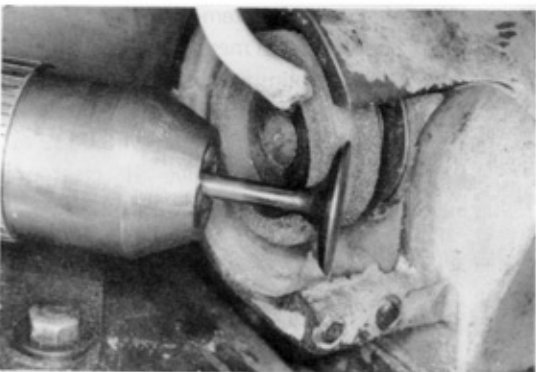

5. Grind valve and seat

- (1) Grind all valves. Remove only enough metal to remove pits and carbon.

Valve face angle : 45°

Fig. 4-26

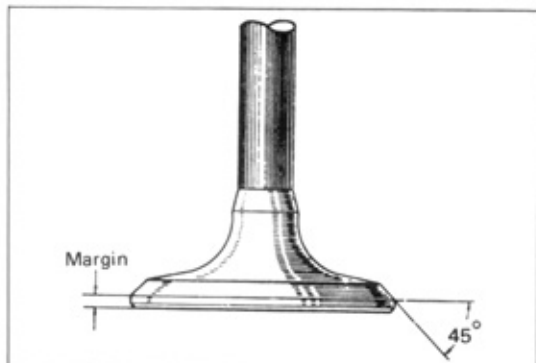

- (2) Check margin.

If valve head margin is less than specification, replace valve.

Margin limit

Intake 0.6 mm (0.024 in)

Exhaust 0.6 mm (0.024 in)

Fig. 4-27

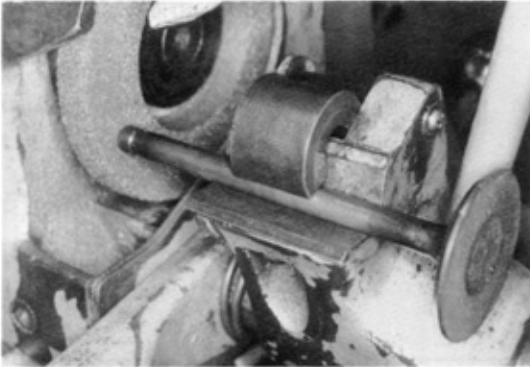

Fig. 4-28

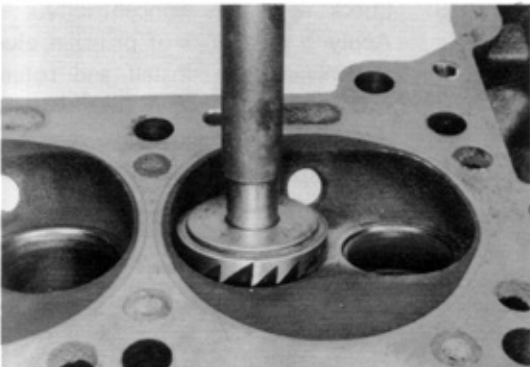

Fig. 4-29

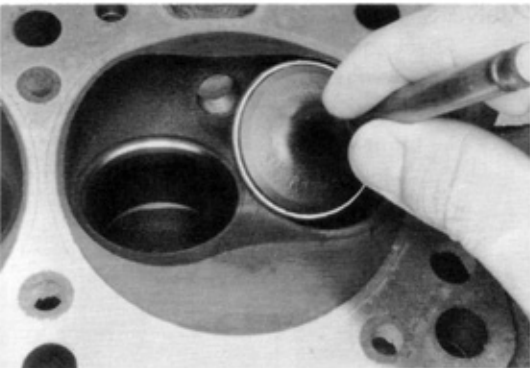
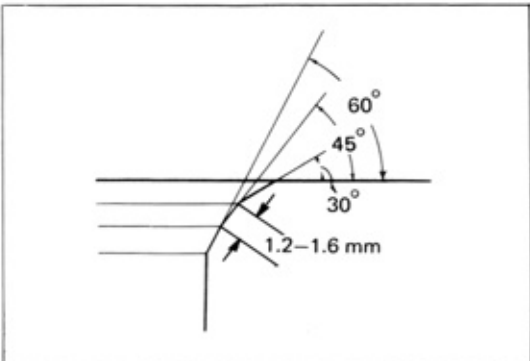

Fig. 4-30



- (3) If valve stem tip has been worn by rocker arm, resurface with valve grinder.
Do not grind more than 0.5 mm (0.02 in).

**Overall length limit 112.7 mm
(4.437 in)**

- (4) Resurface valve seats with 45° carbide cutter.
Remove only enough metal to clean seat.

- (5) Coat valve face with prussian blue or white lead. Locate contact point on valve by rotating valve against seat.

— Note —

Seat contact should be in middle of valve face with following width:

Intake 1.2–1.6 mm (0.047–0.063 in)

Exhaust 1.2–1.6 mm (0.047–0.063 in)

- (6) Correct seat position.
To correct seating that is too high, use 30° and 45° cutters. If seating is too low, use 65° and 45° cutters.

Fig. 4-31

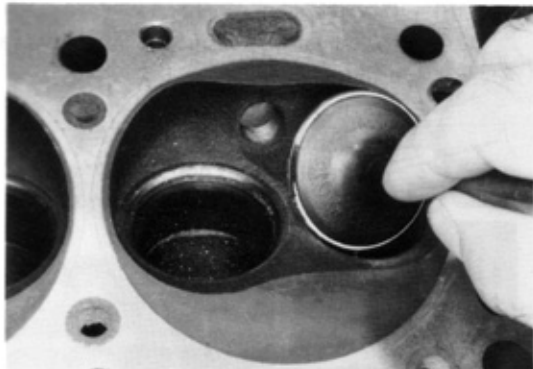

Fig. 4-32

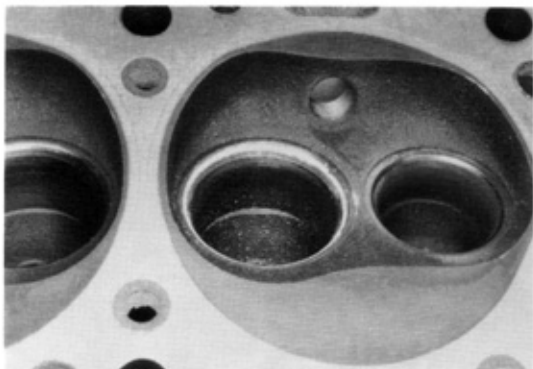

Fig. 4-33

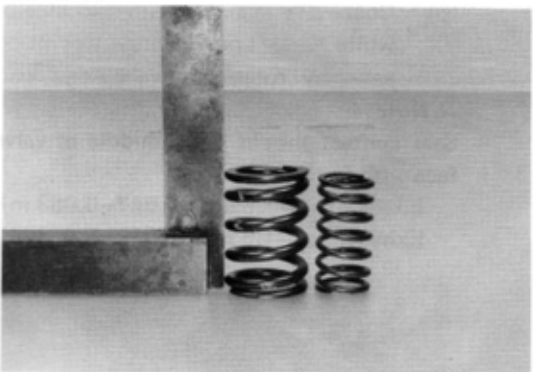
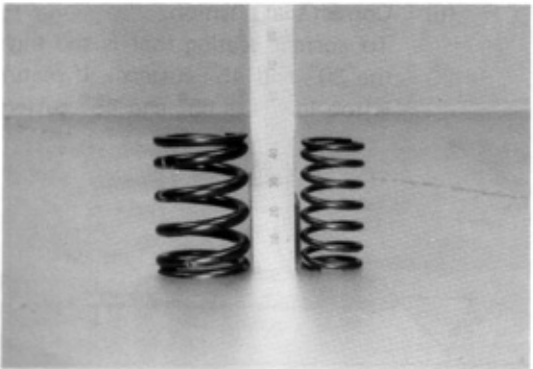

Fig. 4-34



- (7) Check valve concentricity. Lightly coat seat with prussian blue. Install valve and rotate. If blue appears 360° around face, valve stem and face are concentric. If not, replace valve.

- (8) Check seat/guide concentricity. Apply a light coat of prussian blue on valve face. Install and rotate valve. If blue appears 360° around valve seat, guide and seat are concentric. If not, recut seat.



Valve Spring

1. Check squareness of valve springs with steel square. If spring is out of square more than limit, replace.

Limit

| | |
|-------|-------------------|
| Inner | 1.6 mm (0.063 in) |
| Outer | 1.9 mm (0.075 in) |



2. Measure free height of all springs. Replace any spring that is out of specification.

Free height

| | |
|-------|--------------------|
| Inner | 44.1 mm (1.736 in) |
| Outer | 46.5 mm (1.830 in) |

Fig. 4-35

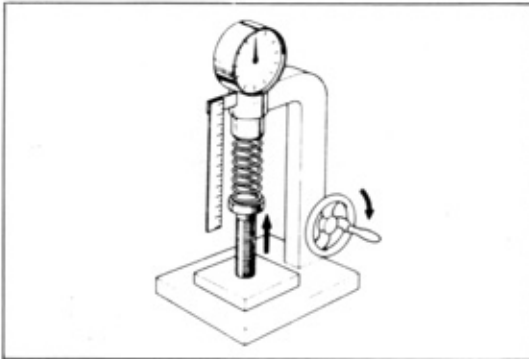

- Using a spring tester, measure tension of each spring at the specified installed height. Replace any spring that does not meet specification.

| | Inner | Outer |
|-----------------|------------------------------------|-------------------------------------|
| Limit | 6.0 kg (13.23 lb) | 19.0 kg (41.89 lb) |
| Standard | 6.9 kg (15.21 lb) | 23.0 kg (50.71 lb) |

Fig. 4-36

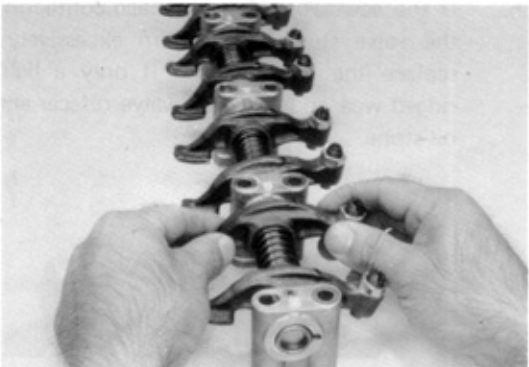

Rocker Arm and Shaft

- Check rocker arm to shaft clearance by moving rocker arm as shown. Little or no movement should be indicated. If movement is felt, disassemble and inspect.

Fig. 4-37

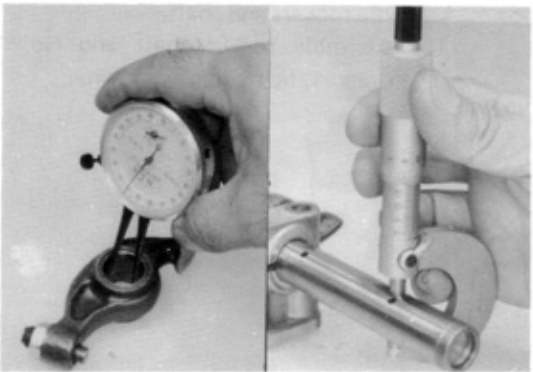

- If movement was felt above, measure rocker oil clearance with dial indicator and outside micrometer. If clearance is excessive, replace rocker arm bushings and/or shaft.

| | |
|------------------------|--|
| Clearance Limit | 0.08 mm (0.0032 in) |
| Standard | 0.02–0.05 mm (0.0008–0.0020 in) |

Fig. 4-38

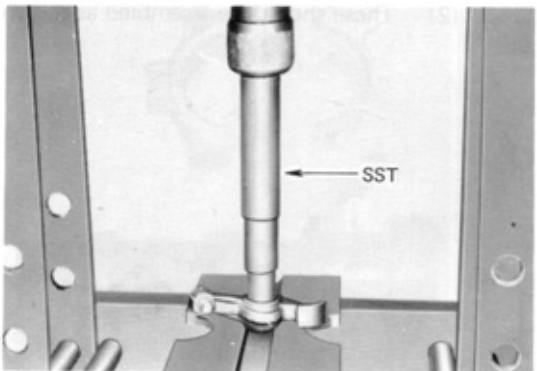

- To remove the rocker arm bushing, use SST [09222-30010].

Fig. 4-39

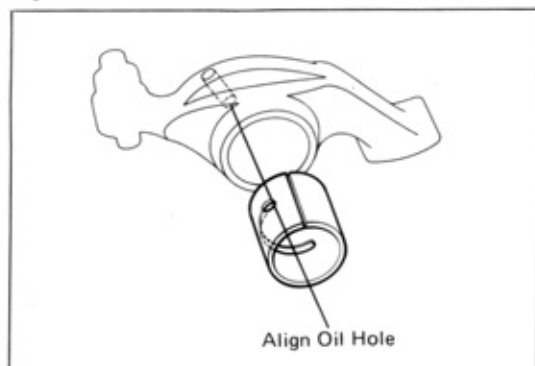

4. When assembling bushing, align oil hole with that of the rocker arm. After assembling, ream bushing to obtain specified oil clearance.

Standard **0.02–0.05 mm**
(0.0008–0.0020 in)

Fig. 4-40

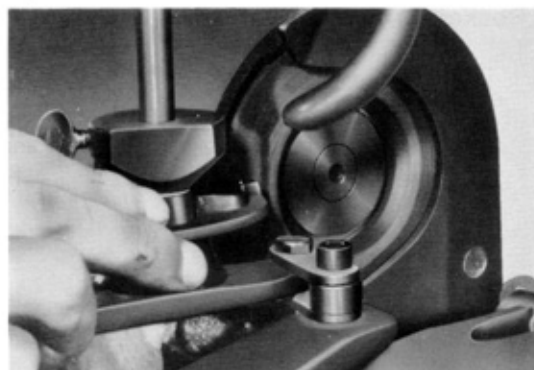

5. If the valve rocker arm surface contacting the valve stem end is worn excessively, replace the rocker arm. If only a light ridged wear, correct with valve refacer and oil stone.

Fig. 4-41

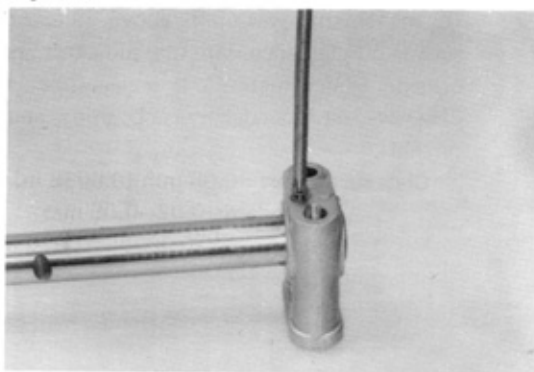

6. Assemble rockers and shaft.
 (1) Assemble rocker shaft and No. 1 support, tightening as shown.

Fig. 4-42

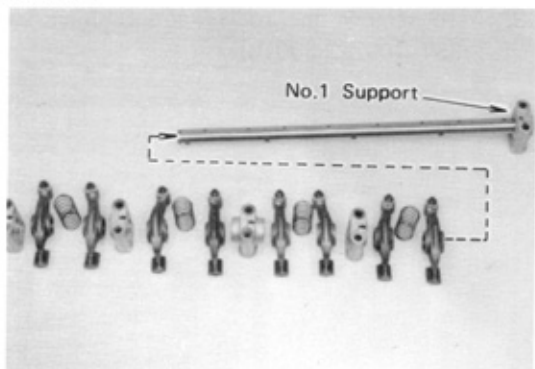

- (2) These should be assembled as shown.

Fig. 4-43

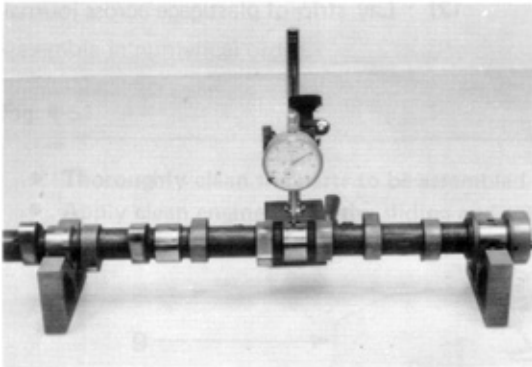
**Camshaft and Bearing**

1. Check camshaft for runout and if it exceeds limit replace.

Runout limit 0.1 mm 0.004 in

Fig. 4-44

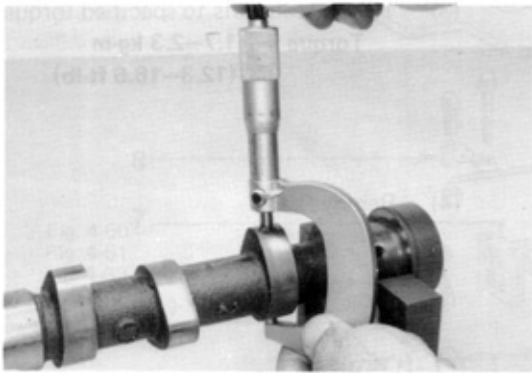

2. Measure cam lobe height. If wear exceeds limit, replace camshaft.

Height limit Intake 43.7 mm (1.720 in)

Exhaust 43.8 mm (1.724 in)

Fig. 4-45

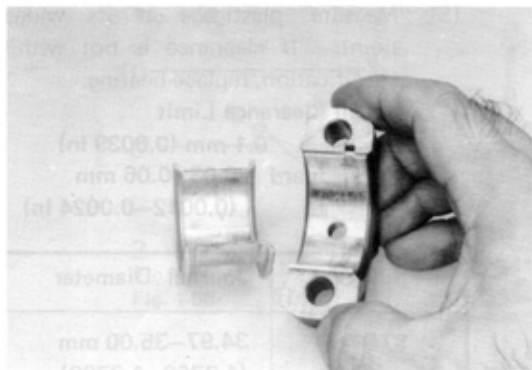

3. Check bearings for flaking or scoring. If bearings are damaged, replace.

Fig. 4-46

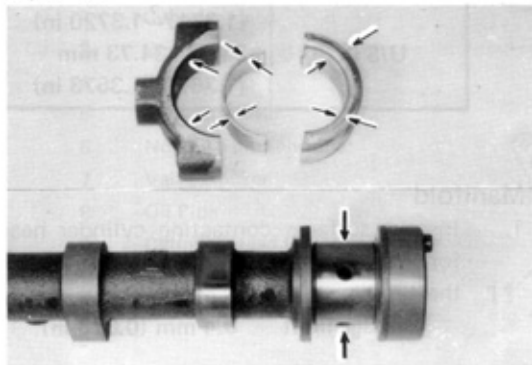

4. Measure camshaft oil clearance.
(1) Clean bearing, cap and camshaft journal.

Fig. 4-47

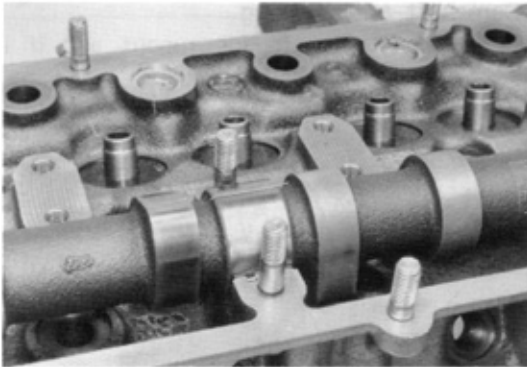

- (2) Lay strip of plastigage across journal.

Fig. 4-48

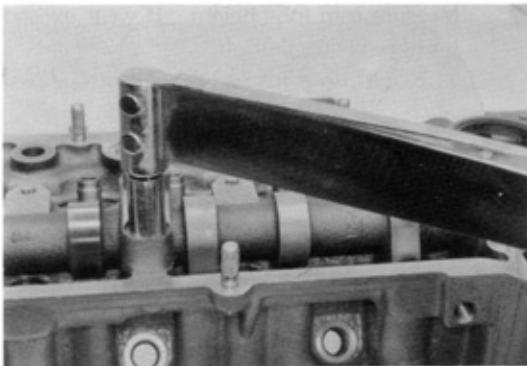

- (3) Tighten cap nuts to specified torque.
Torque 1.7–2.3 kg-m
(12.3–16.6 ft-lb)

- (4) Remove cap.

Fig. 4-49

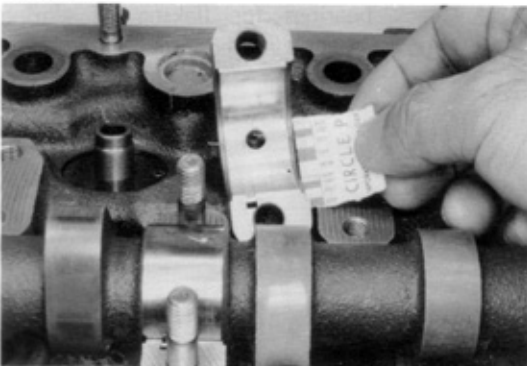

- (5) Measure plastigage at its widest point. If clearance is not within specification, replace bearing.

Oil Clearance Limit

0.1 mm (0.0039 in)

Standard 0.03–0.06 mm

(0.0012–0.0024 in)

Fig. 4-50

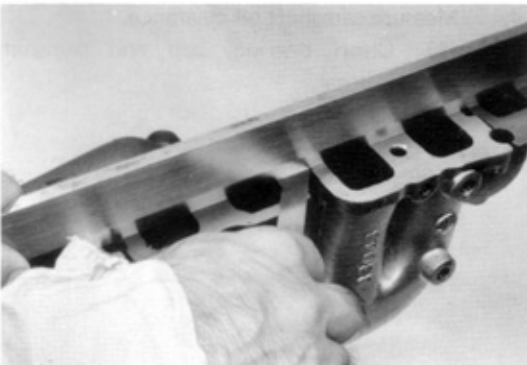

| Bearing Size | Journal Diameter |
|--------------|--------------------------------------|
| STD | 34.97–35.00 mm (1.3768–1.3780) |
| U/S 0.125 | 34.84–34.85 mm (1.3717–1.3720 in) |
| U/S 0.25 | 34.72–34.73 mm (1.3670–1.3673 in) |

Manifold

1. Inspect surfaces contacting cylinder head for warpage, and replace if warped over the limit.

Warpage limit 0.4 mm (0.016 in)

ASSEMBLY

Assemble in numerical order.

Fig. 4-51

- Thoroughly clean the parts to be assembled.
- Apply clean engine oil on the sliding and rotating surfaces of the parts before assembly.

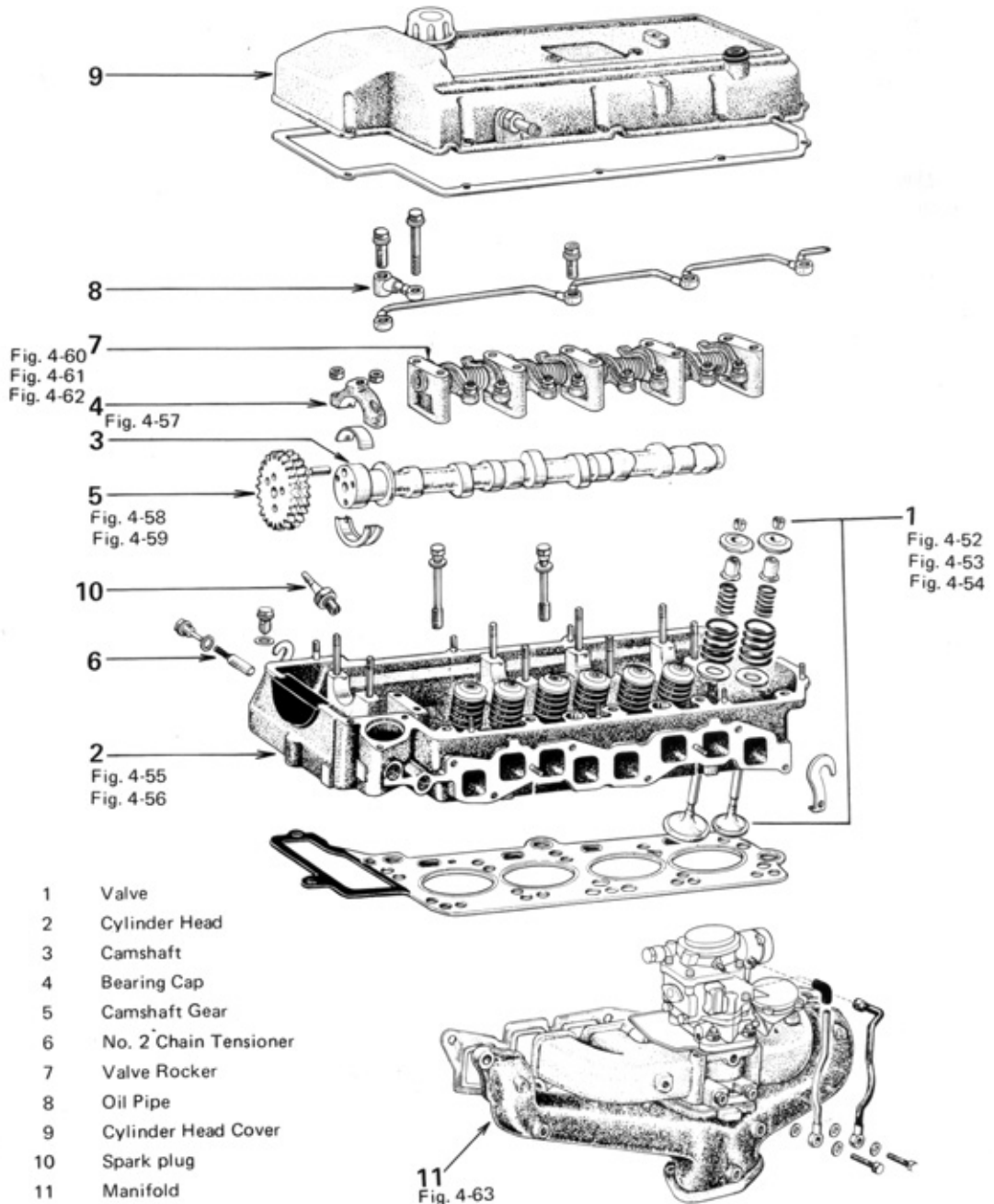
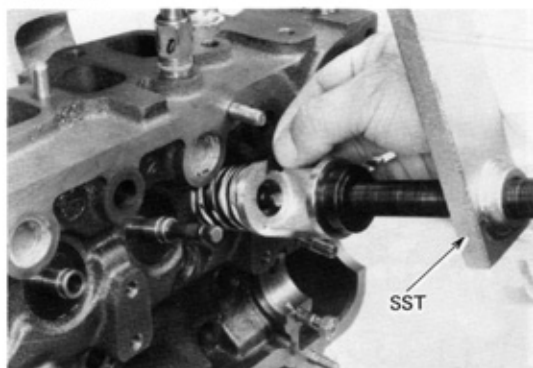

Fig. 4-52



Assemble spring seat and oil seal as shown. The oil seal should be inserted until its end contacts spring seat top.

Fig. 4-53



Compress the valve spring with SST [09202-43011] and install retainer locks.

Fig. 4-54



After assembling valve spring, tap stem lightly to assure proper fit.

Fig. 4-55

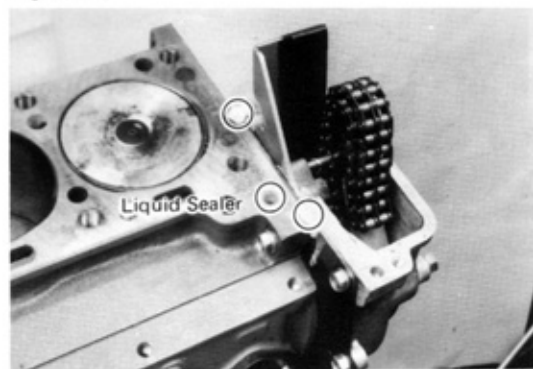

Apply liquid sealer on the cylinder head, around the oil holes in the block, and in the vicinity of the timing chain cover and cylinder block.

Fig. 4-56

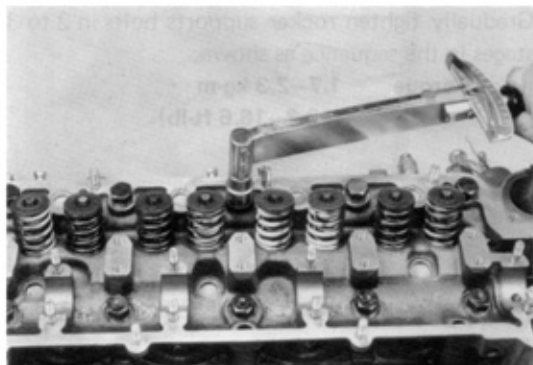

Gradually tighten cylinder head bolts in 2 to 3 stages in the sequence as shown.

Torque 10–12 kg-m (72.3–86.8 ft-lb)

Fig. 4-57

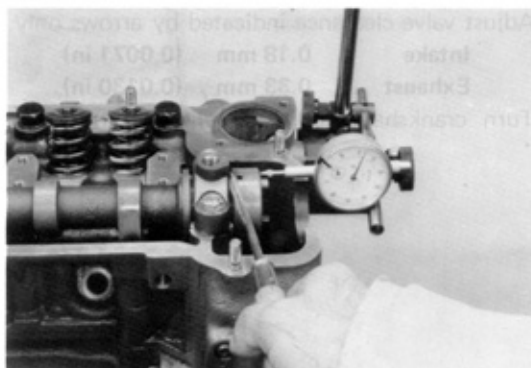

Make sure of camshaft thrust clearance.

Thrust Clearance Standard

0.15–0.30 mm (0.0059–0.0118 in)

Fig. 4-58

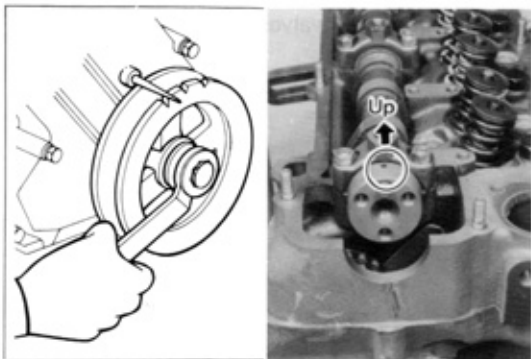

Set to No. 1 cylinder TDC/compression.
Camshaft knock pin should point up.

Fig. 4-59



Align chain and gear with marking made.

Install the No. 2 chain with its mark aligned with the gear mark.

Align gear pin hole and camshaft knock pin and install them.

Fig. 4-60

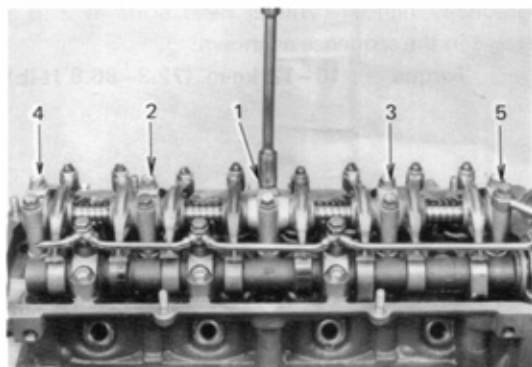

Gradually tighten rocker supports bolts in 2 to 3 stages in the sequence as shown.

**Torque 1.7–2.3 kg-m
(12.3–16.6 ft-lb)**

Fig. 4-61

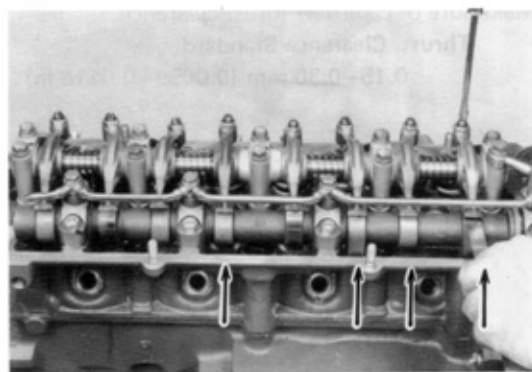

Adjust valve clearance indicated by arrows only.

Intake 0.18 mm (0.0071 in)

Exhaust 0.33 mm (0.0130 in)

Turn crankshaft 360° and align timing mark.

Fig. 4-62

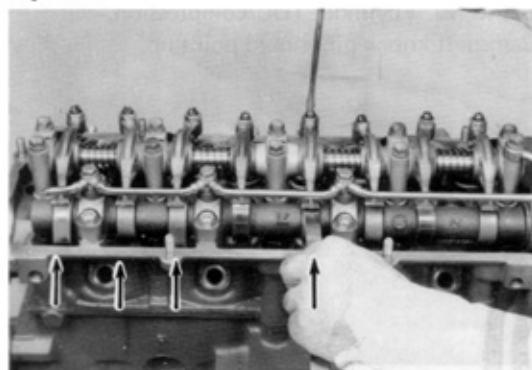

Adjust remaining valves indicated by arrows.

Fig. 4-63

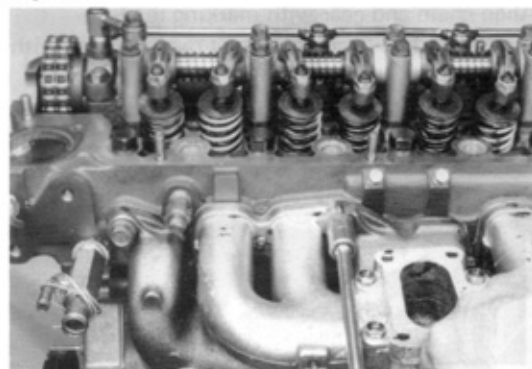

Tighten the manifold securing nuts in the sequence as shown.

**Torque 4.5–5.5 kg-m
(32.6–39.8 ft-lb)**

TIMING CHAIN

DISASSEMBLY

Disassemble in numerical order.

Fig. 4-65

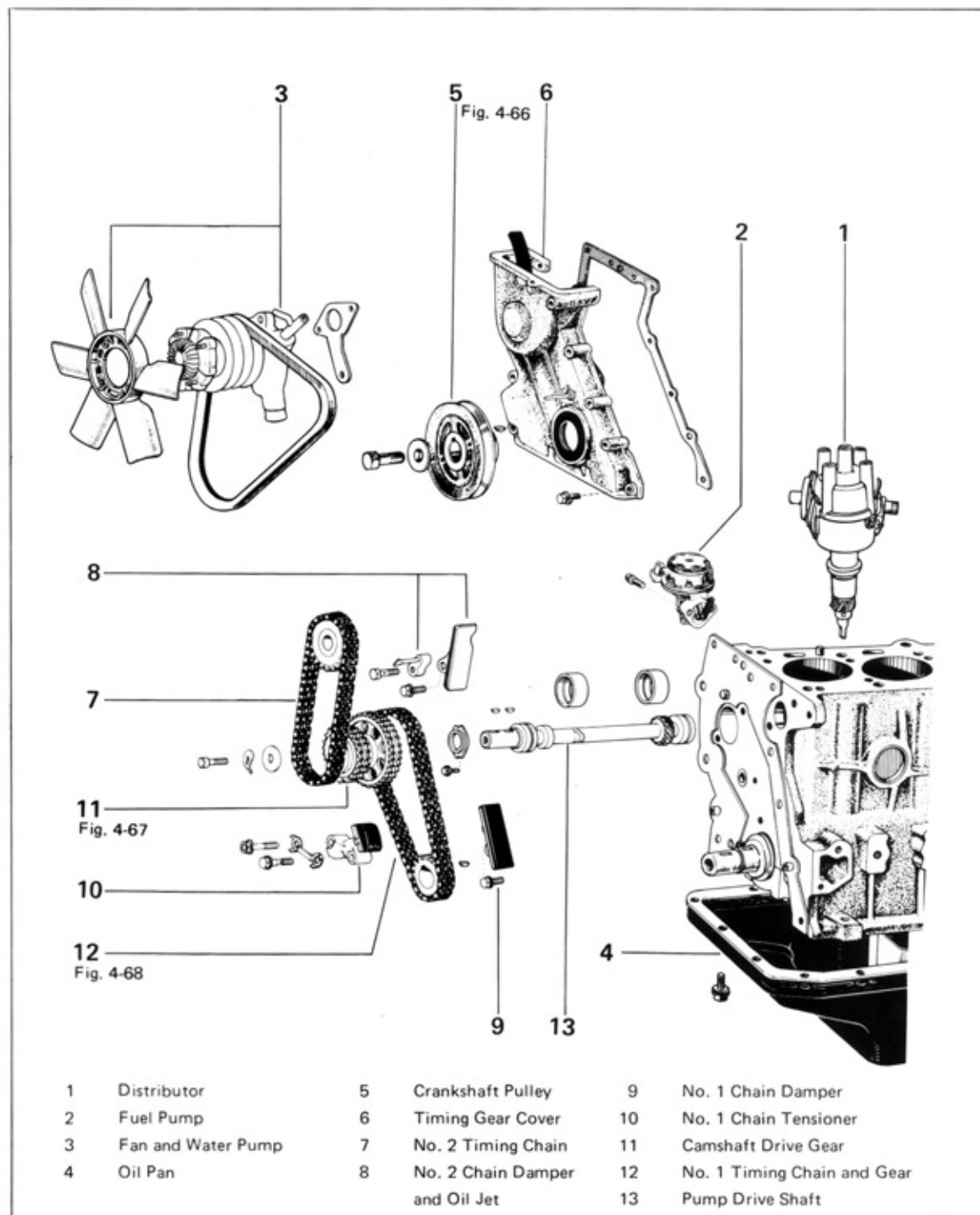
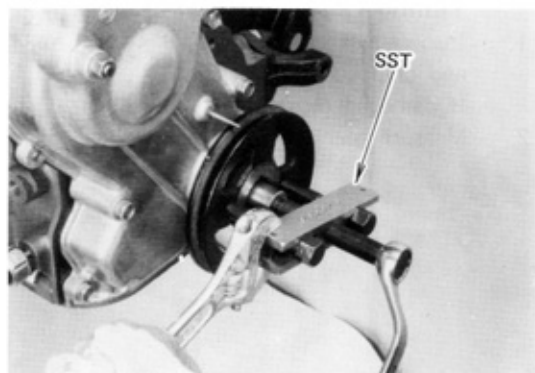
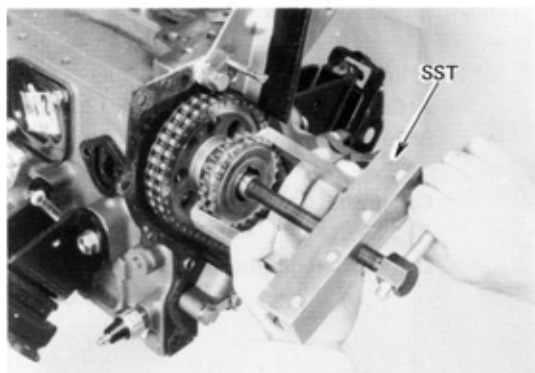

Fig. 4-66



Pull out crankshaft pulley.
Use SST [09213-31021].

Fig. 4-67



Pull out camshaft drive gear.
Use SST [09213-36010].

Fig. 4-68

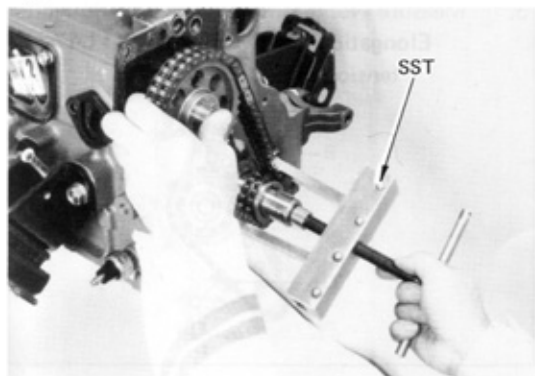

When removing these gears, hook the SST [09213-36010] alternately on the two gears and pull them out uniformly.

Fig. 4-70

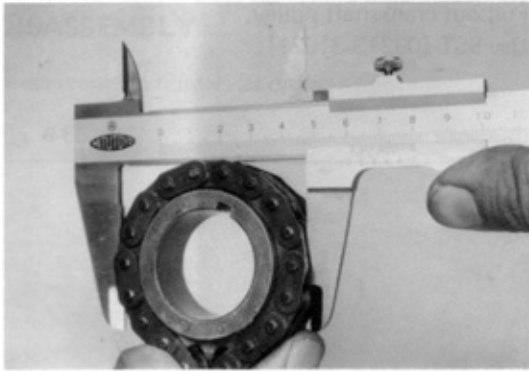

Fig. 4-71

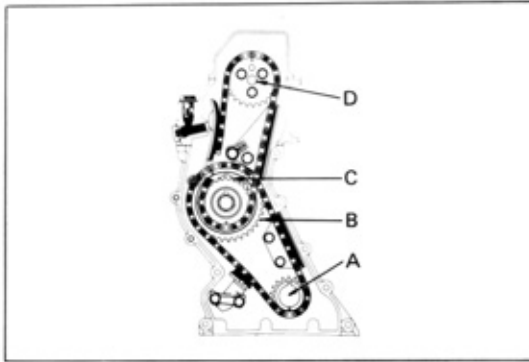

Fig. 4-72

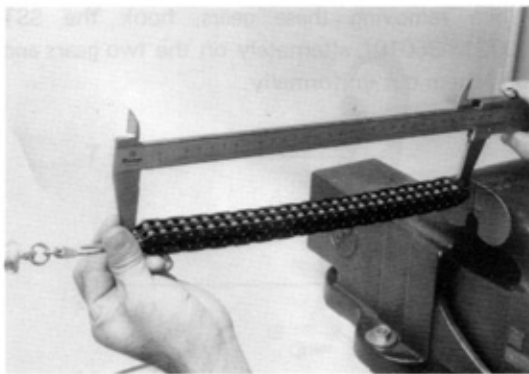
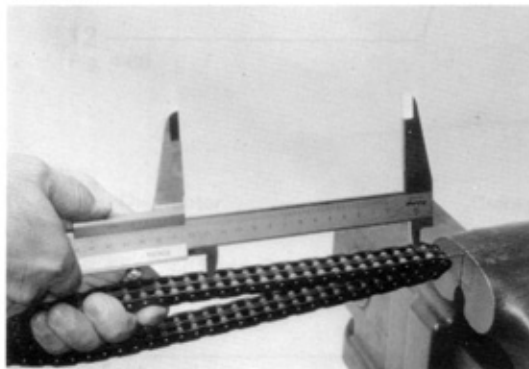

Fig. 4-73



INSPECTION AND REPAIR Timing Gear and Chain



1. Inspect gear and chain for cracks, wear, and chipped teeth.
If damaged replace gears and chain.
2. Measure gear for wear as shown.



If measurement is below limit, replace gears and chain.

Wear limit

| | |
|--------------------------|---------------------|
| A: Crank shaft gear | 60.0 mm (2.362 in) |
| B: Pump drive shaft gear | 114.5 mm (4.508 in) |
| C: Camshaft drive gear | 78.2 mm (3.079 in) |
| D: Camshaft timing gear | 78.2 mm (3.079 in) |



3. Measure No. 1 timing chain for elongation.
**Elongation limit 291.4 mm (11.47 in)
tension at 5kg (11 lb)**



4. Measure No. 2 timing chain for elongation. Measure the length of 17 links with the chain stretched tight with the force of one hand. Make the same measurements at more than three other places selected at random.
If over the limit at any one place, replace the chain.

| | |
|-------------------------|--------------------------|
| Elongation limit | (at 17 links) |
| | 147 mm (5.787 in) |

Fig. 4-74

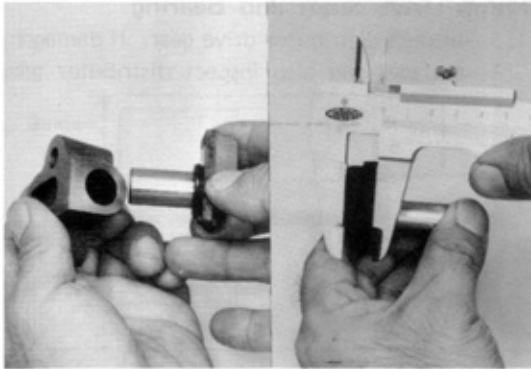
**No. 1 Chain Tensioner**

Inspect body and plunger for wear.

Measure tensioner head as shown.

If worn below limit, replace unit.

**Wear limit** 11.5 mm (0.453 in)

Fig. 4-75

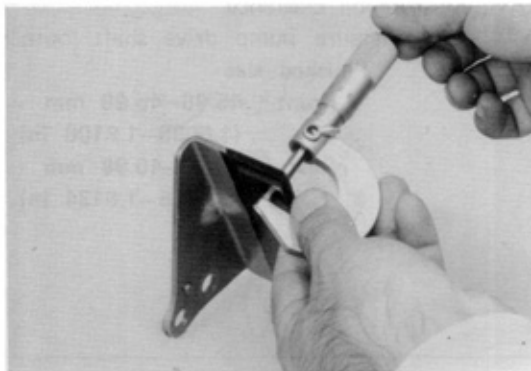
**Chain Damper and Slipper**

Inspect chain dampers for wear. Measure each damper.

Fig. 4-76

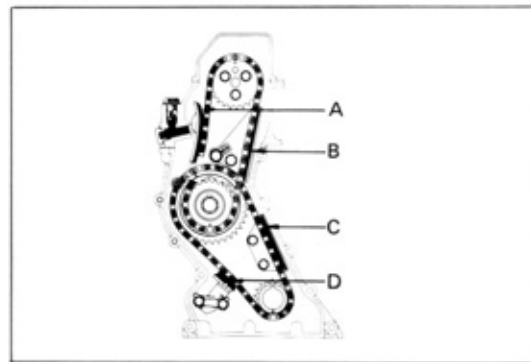

If either is visibly worn or measures less than limit, replace unit

Wear limit**A: Slipper**

6.8 mm (0.26 in)

B: No. 2 damper

5.0 mm (0.20 in)

C: No. 1 damper

5.0 mm (0.20 in)

D: No. 1 tensioner

11.5 mm (0.45 in)

Fig. 4-77

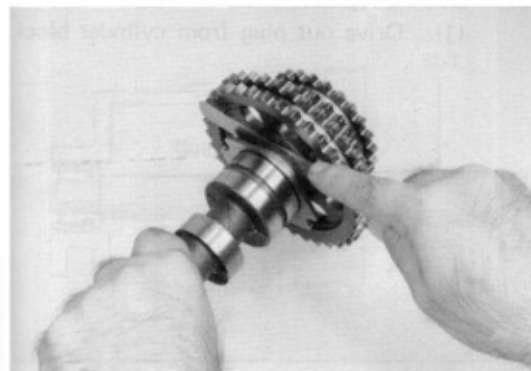
**Timing Gear and Thrust Plate**

Measure thrust clearance.

If it exceeds limit, replace thrust plate.

Thrust clearance**limit** 0.3 mm (0.012 in)**Standard**

0.06–0.13 mm (0.0024–0.0051 in)

Fig. 4-78

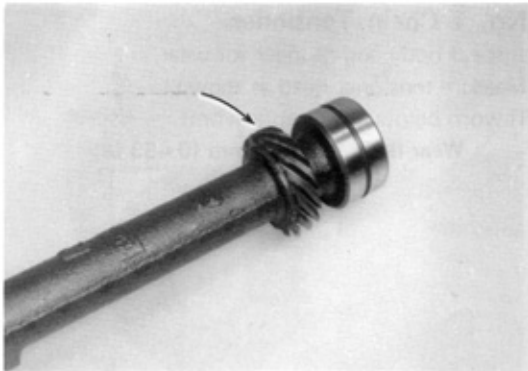

Fig. 4-79

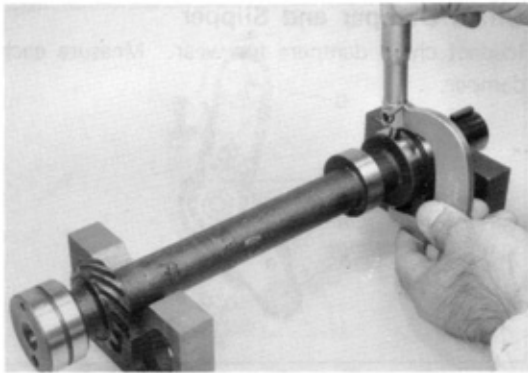

Fig. 4-80

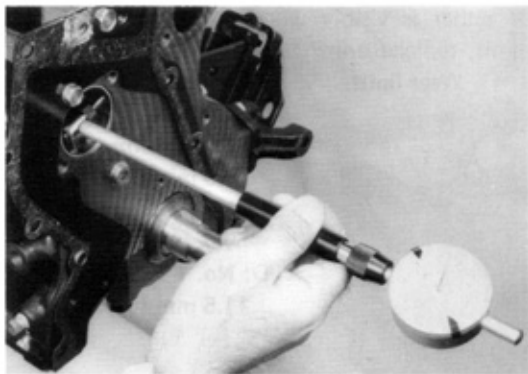
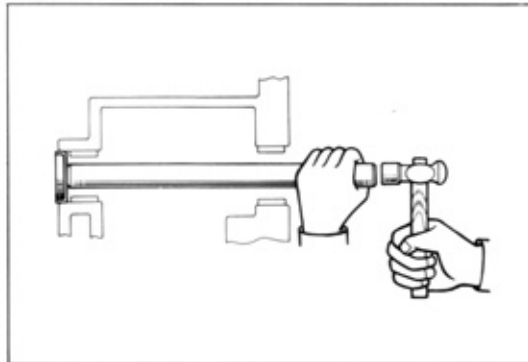

Fig. 4-81



Pump Drive Shaft and Bearing

1. Inspect distributor drive gear. If damaged, replace, and also inspect distributor gear.



2. Measure oil clearance
 - (1) Measure pump drive shaft journal.

Finished size

Front 45.96–45.98 mm
(1.8098–1.8106 in)

Rear 40.96–40.98 mm
(1.6126–1.6134 in)



- (2) Measure inner diameter of bearing.

Oil clearance limit

0.08 mm (0.0032 in)

Standard

0.03–0.07 mm
(0.0008–0.0024 in)



3. Bearing replacement
 - (1) Drive out plug from cylinder block.

Fig. 4-82

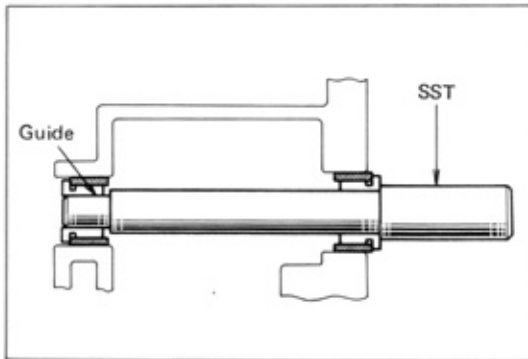

- (2) Remove front bearing.
Use SST [09233-33010] as shown.

Fig. 4-83

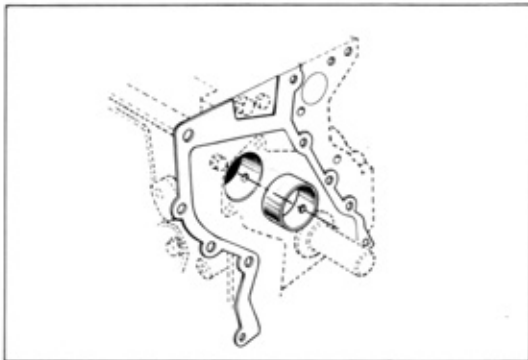

- (3) Align bearing oil hole.

Fig. 4-84

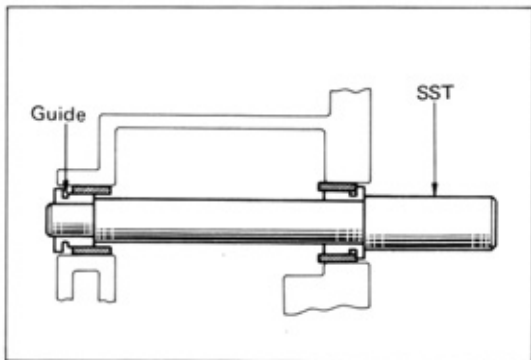

- (4) Install front bearing.
Use SST [09233-33010] as shown.
Bearing fitting tolerance
0.02–0.06 mm
(0.0008–0.0024 in)

Fig. 4-85

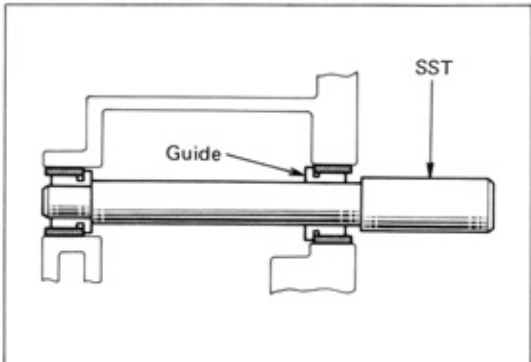

- (5) Remove rear bearing.
Replacement for rear bearing as same
as front bearing.

Fig. 4-86

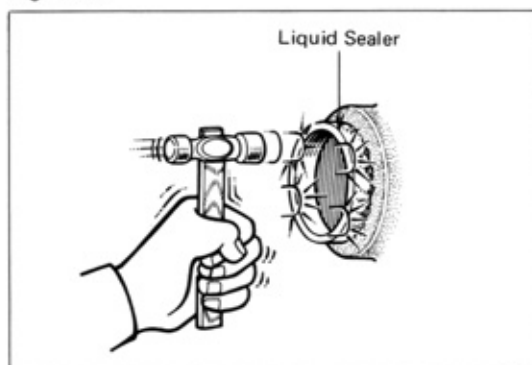

- (6) Install new plug applied with liquid sealer.

Fig. 4-87



Crankshaft Front Oil Seal Replacement

1. Remove oil seal with a screwdriver.

Fig. 4-88

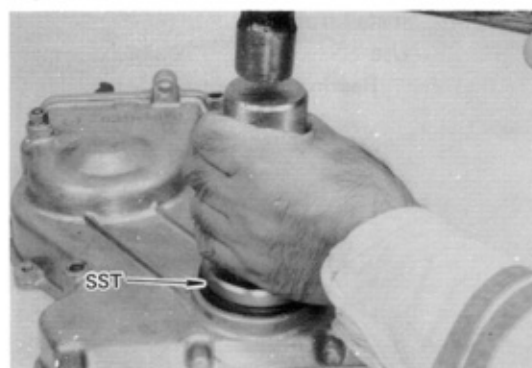

2. Install new oil seal.
Use SST [09223-50010] as shown.

Fig. 4-89

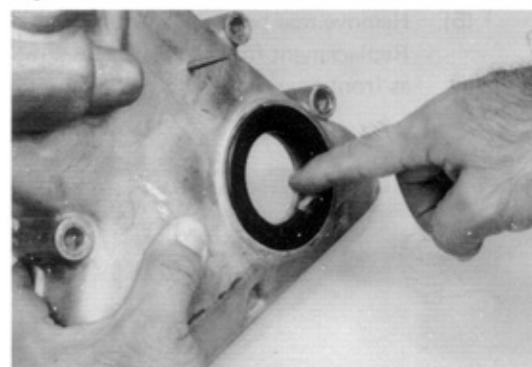

3. After driving in the seal, be sure to coat the seal lip lightly with MP grease.

ASSEMBLY

Assemble in numerical order.

Fig. 4-90

- Thoroughly clean the parts to be assembled.
- Apply clean engine oil on the sliding and rotating surfaces of the parts before assembly.

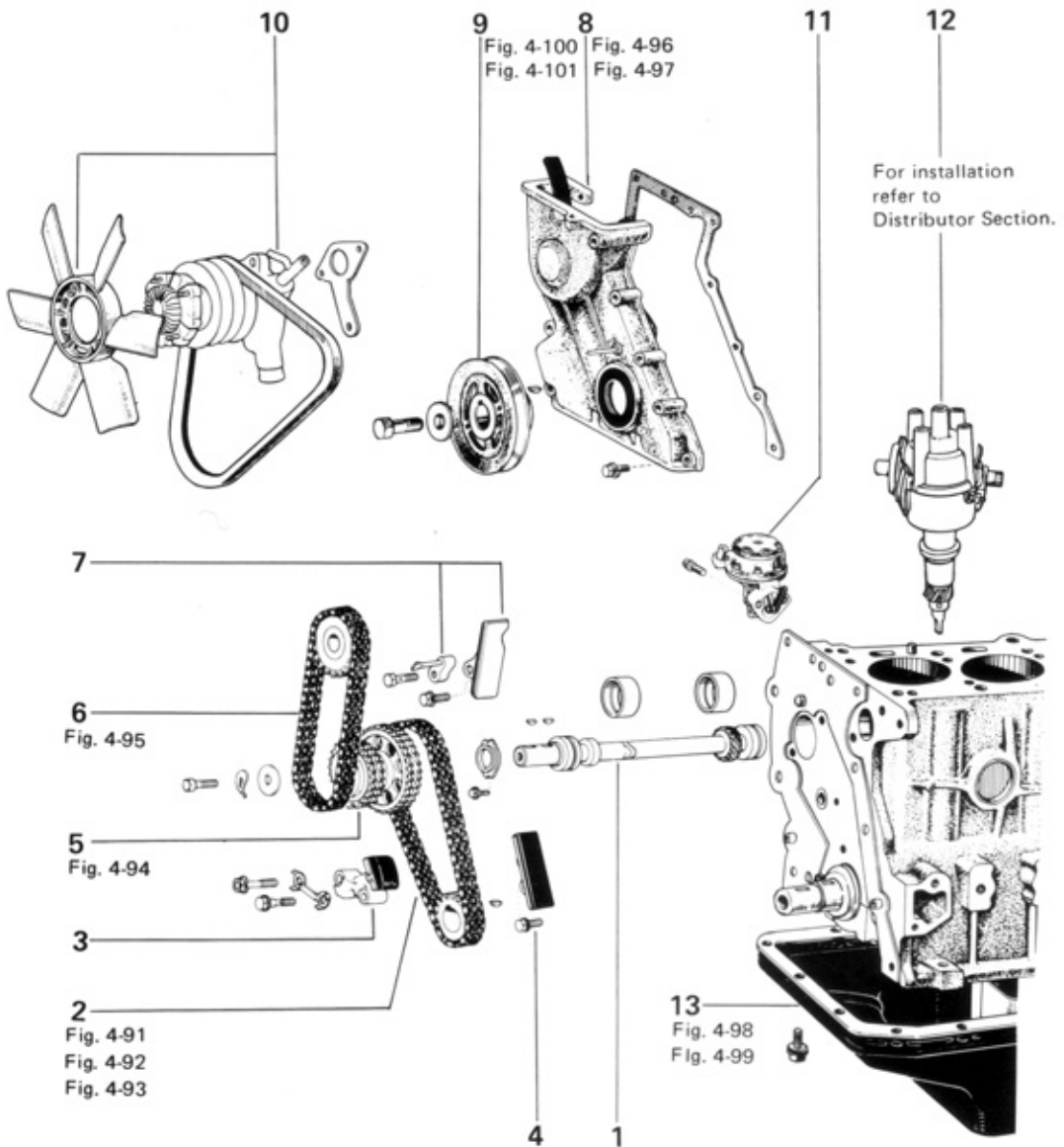

- | | | | | | |
|---|-----------------------------|---|---------------------|----|--------------------|
| 1 | Pump Drive Shaft | 5 | Camshaft Drive Gear | 9 | Crankshaft Pulley |
| 2 | No. 2 Timing Chain and Gear | 6 | No. 2 Timing Chain | 10 | Fan and Water Pump |
| 3 | No. 1 Chain Tensioner | 7 | No. 2 Chain Damper | 11 | Fuel Pump |
| 4 | No. 1 Chain Damper | 8 | Timing Gear Cover | 12 | Distributor |
| | | | | 13 | Oil Pan |

Fig. 4-91

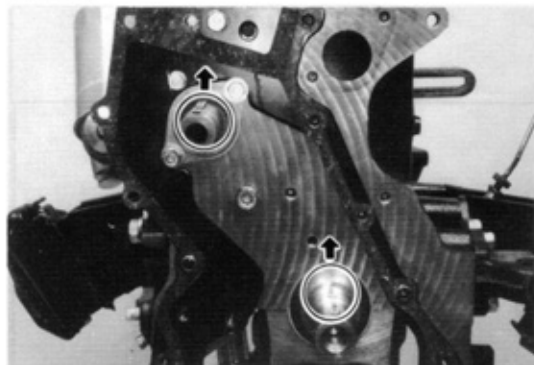

Set the crankshaft keyway and the pump drive shaft keyway vertically upward.

Fig. 4-92



Assemble the crankshaft timing gear and pump drive shaft gear to the No. 2 chain so that their respective marks are aligned.

Fig. 4-93

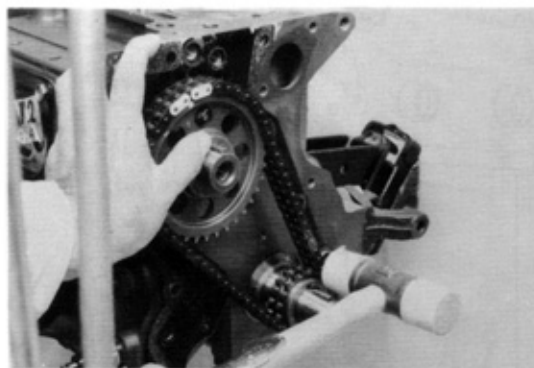

Drive in No. 1 chain and gears on to the crankshaft and pump driveshaft.

Fig. 4-94

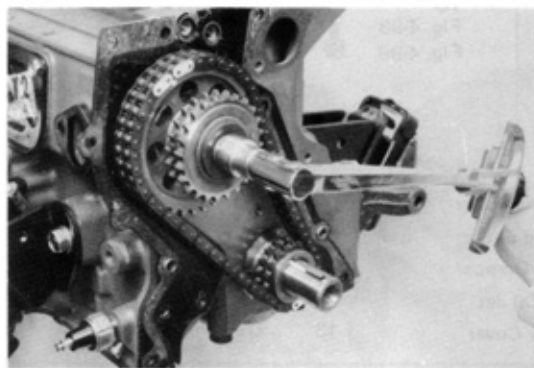

Tighten camshaft drive gear bolt.

Torque

8.0–10.0 kg-m (57.9–72.3 ft-lb)

Fig. 4-95



Install No. 2 chain aligned with the chain and gear marks.

Fig. 4-96

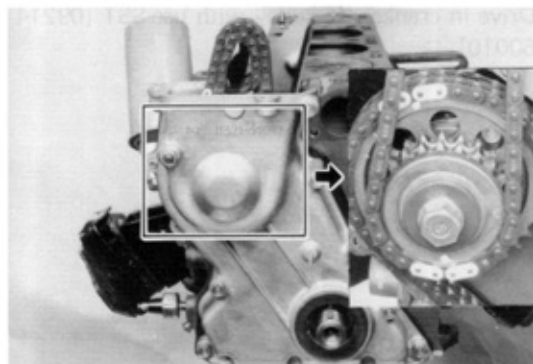

Be careful not to fall the No. 2 chain into the cover.

Fig. 4-97

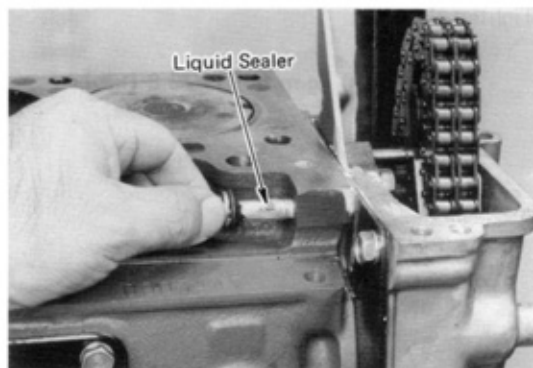

In installing the upper right bolt for mounting the chain cover, insert seal washer and apply liquid sealer on the threads.

Fig. 4-98

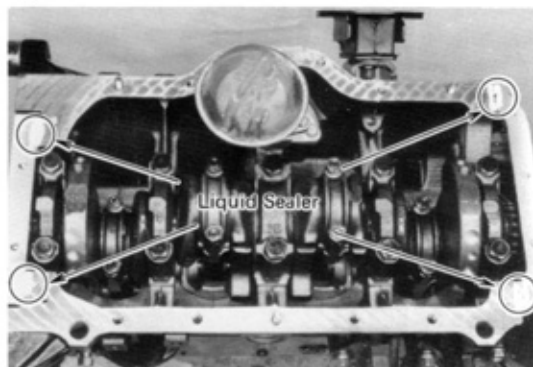

Apply liquid sealer as shown.

Fig. 4-99

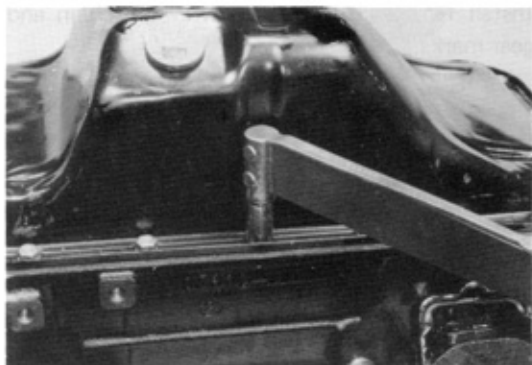

Install oil pan.

Torque**0.4–0.8 kg-m (2.9–5.8 ft-lb)**

Fig. 4-100

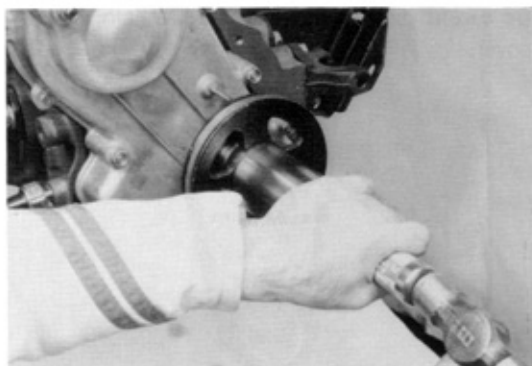

Drive in crankshaft pulley with use SST [09214-60010].

Fig. 4-101

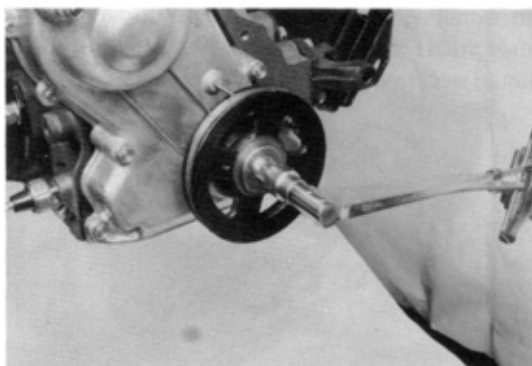

Tighten claw nut.

Torque**9.0–11.0 kg-m (65.1–79.6 ft-lb)**

CYLINDER BLOCK DISASSEMBLY

Disassemble in numerical order

Fig. 4-110

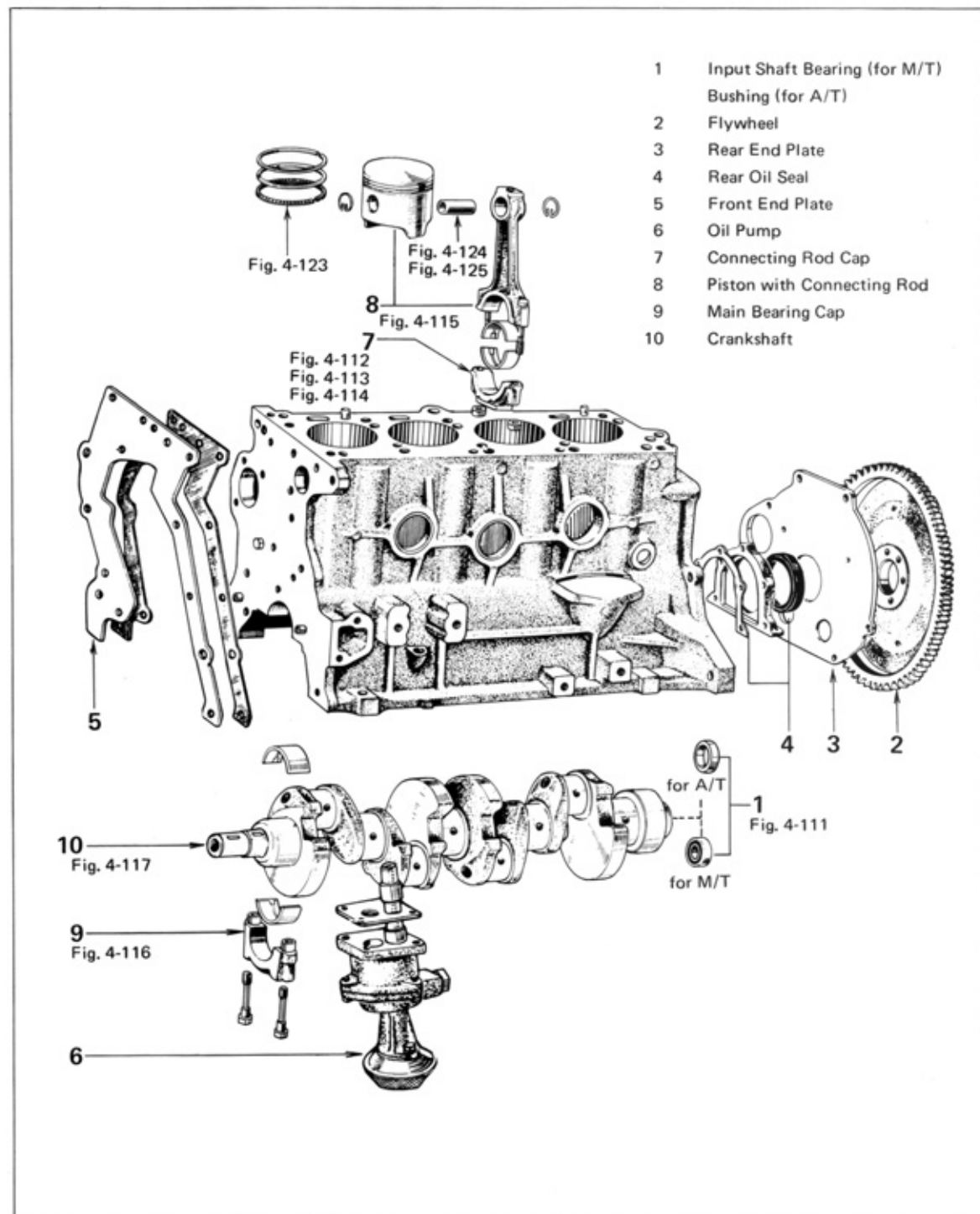
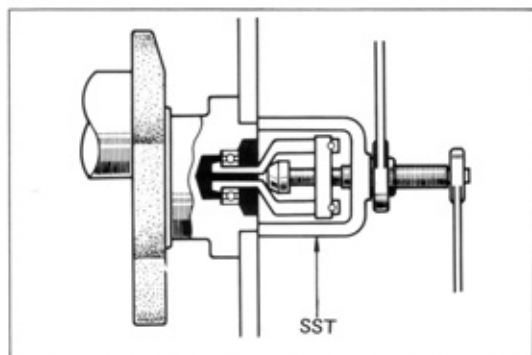
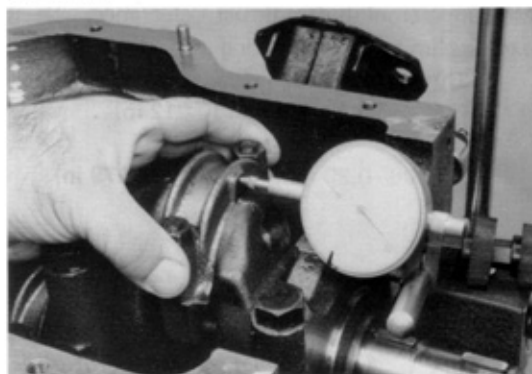

Fig. 4-111



Using SST [09303-35010], remove input shaft bearing.

Fig. 4-112



Measure connecting rod thrust clearance. If it exceeds limit, replace connecting rod.

Thrust clearance limit

0.3 mm (0.012 in)

Standard

0.16–0.26 mm (0.0063–0.010 in)

Fig. 4-113



Mark connecting rod and cap for correct reassembly.

Fig. 4-114

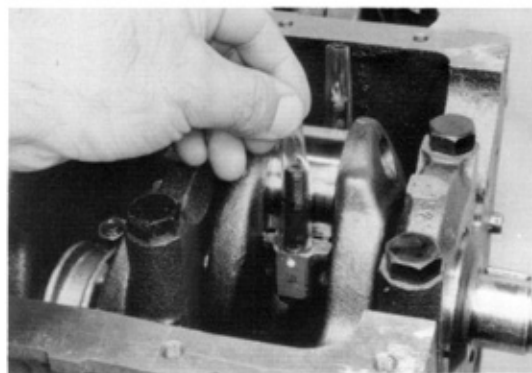

Cover rod bolts with a short length of hose to protect crankshaft from damage.

Fig. 4-115



Keep connecting rod and bearing in order.

Fig. 4-116

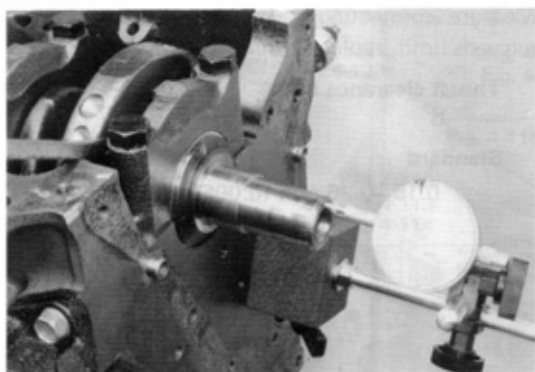

Measure crankshaft thrust clearance. If it exceeds limit, replace bearing as a set.

Thrust clearance limit
0.3 mm (0.012 in)

Standard
0.06–0.20 mm (0.0024–0.0079 in)

Fig. 4-117

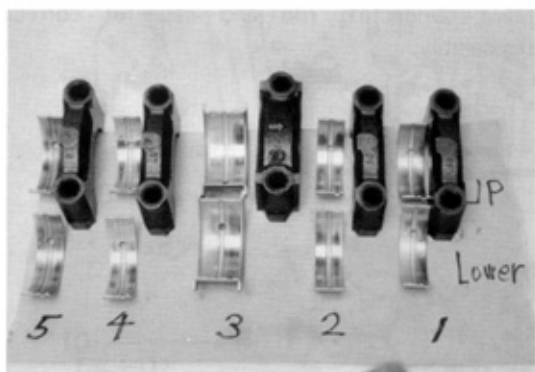

Keep crankshaft bearing and cap in order.

Fig. 4-118

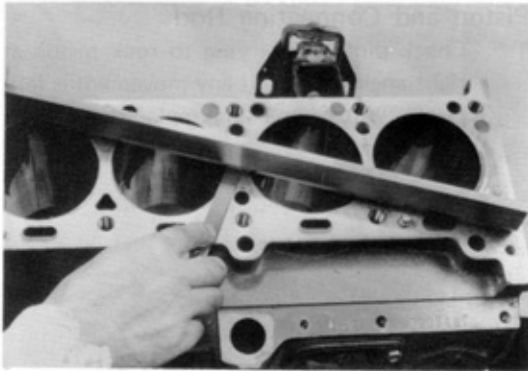

Fig. 4-119

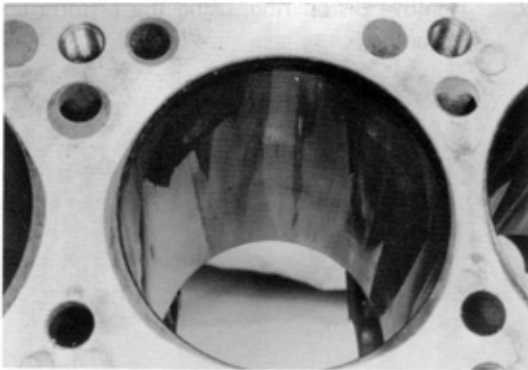

Fig. 4-120

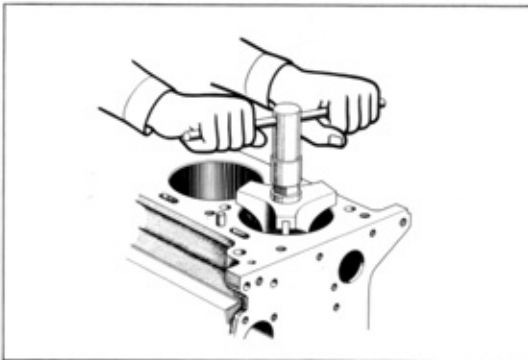
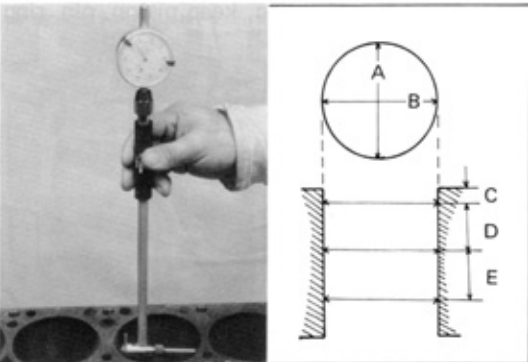

Fig. 4-121

**INSPECTION & REPAIR****Cylinder Block**

1. Check block gasket surface for flatness. If warpage exceeds limit, correct by machining or replace block.

Warpage limit 0.05 mm (0.0019 in)



2. Visually inspect cylinders for vertical scratches. If deep scratches are present, cylinder must be rebored.

3. Machine piston ring ridge from top of cylinder.

— Note —

If this step is not performed prior to removing pistons, piston ring lands will be damaged.



4. Measure cylinder bore at position as shown.

A : Thrust Direction

B : Axial Direction

C : 15 mm (0.59 in)

D : 60 mm (2.36 in)

E : 60 mm (2.36 in)

If bore exceeds specification, it must be rebored.

Wear limit 0.2 mm (0.008 in)

Standard 88.50–88.55 mm

(3.4842–3.4862 in)

Fig. 4-122

**Piston and Connecting Rod**

1. Check pin fit by trying to rock piston at right angle to pin. If any movement is felt, piston with pin must be replaced.

Fig. 4-123

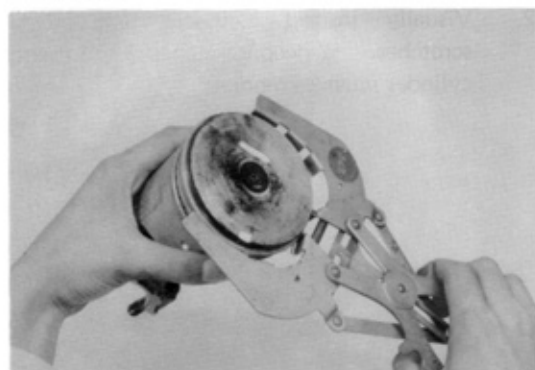

2. Remove piston ring, using the piston ring expander.

Fig. 4-124

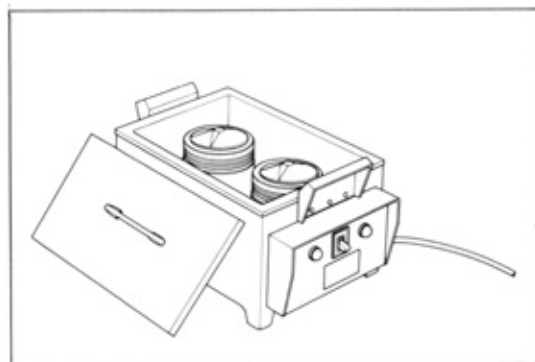

3. Heat piston in piston heater to about 100°C (212°F) and remove piston pin.

Fig. 4-125

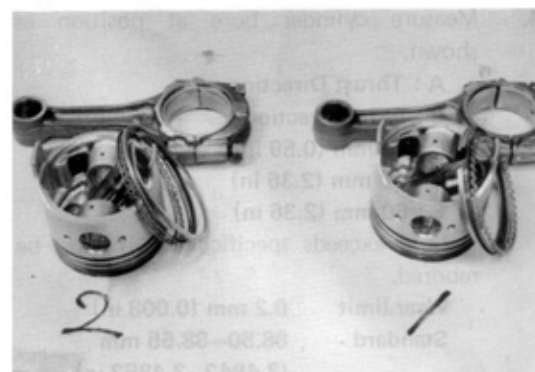

4. After disassembling, keep piston, pin, ring and rod in order.

Fig. 4-126

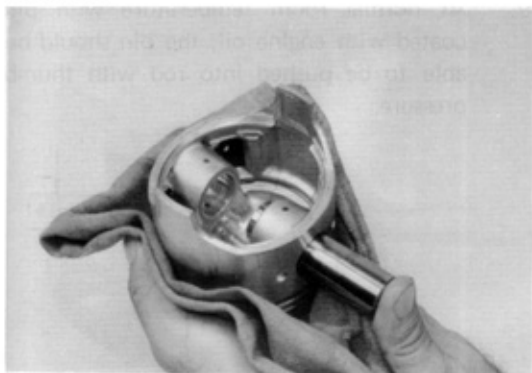

5. Heat piston to 100°C (212°F) coat pin with engine oil.
The pin should be able to be pushed into piston hole with thumb pressure.

Fig. 4-127

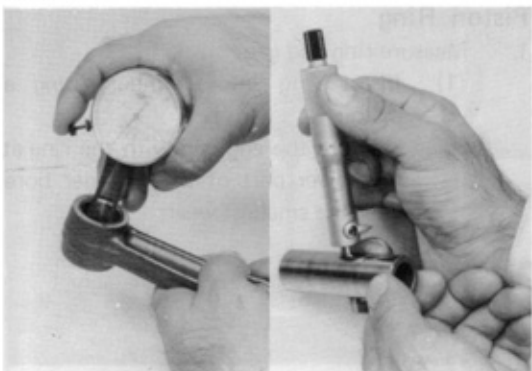

6. Measure oil clearance between bush and pin.

Oil Clearance limit
0.02 mm (0.0008 in)

Fig. 4-128

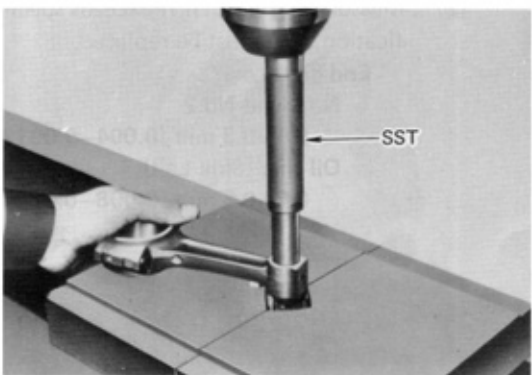

7. Replace bushing with SST [09222-30010].

Fig. 4-129

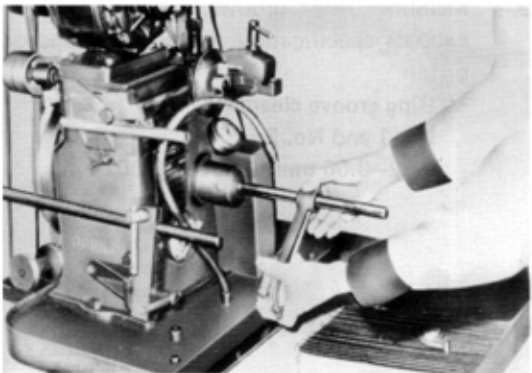

8. After pressing in the bushing, finish the bushing bore with a pin hole grinder.

Fig. 4-130



Fig. 4-131

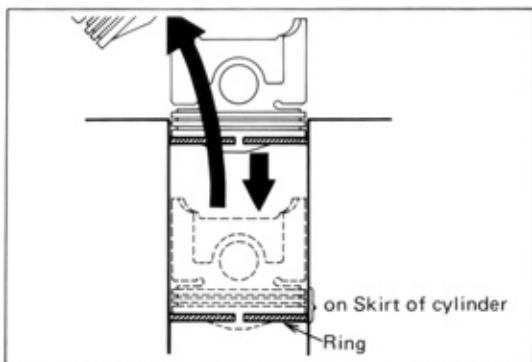

Fig. 4-132

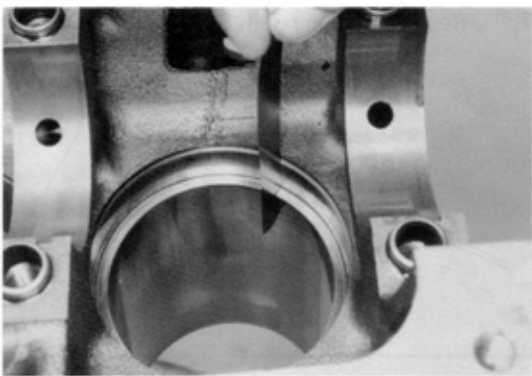
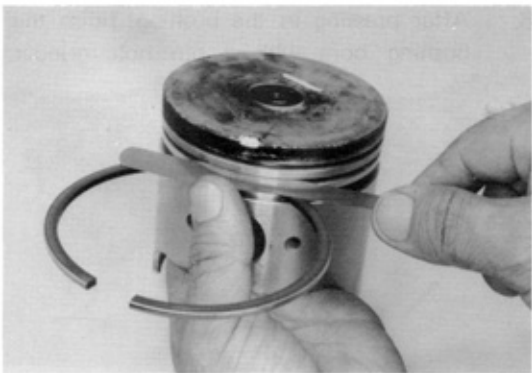

Fig. 4-133



9. At normal room temperature with pin coated with engine oil, the pin should be able to be pushed into rod with thumb pressure.



Piston Ring

1. Measure ring end gap.
 - (1) Insert ring into cylinder using a piston. Measure the end gap with the ring at the lower part of the cylinder bore with the smallest wear.



- (2) Measure end gap. If it exceeds specification, ring must be replaced.

End gap:

No.1 and No.2

0.1–0.3 mm (0.004–0.0012 in)

Oil ring (Side Lail)

0.2–0.5 mm (0.008–0.020 in)



2. Measure ring groove clearance. If it exceeds specification, replace ring and/or piston.

Ring groove clearance

No. 1 and No. 2

0.02–0.06 mm (0.0008–0.0024 in)

Fig. 4-134



Fig. 4-135

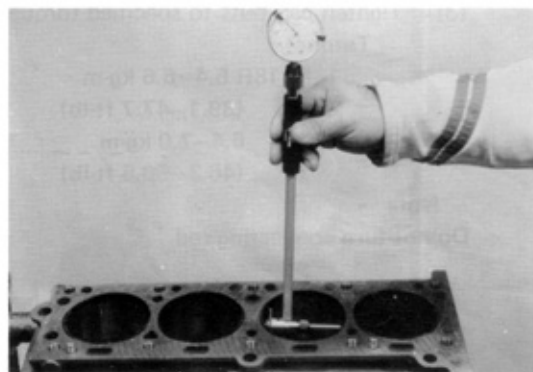

Fig. 4-136

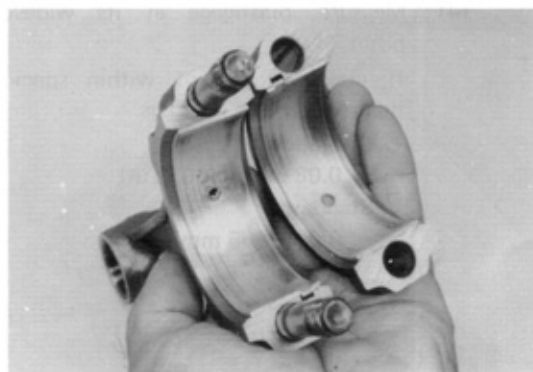
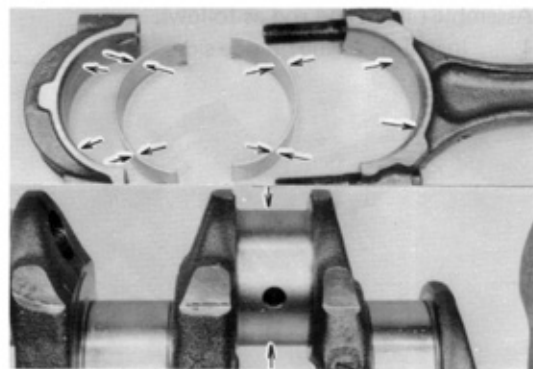

Fig. 4-137



Piston Clearance

1. Measure piston diameter at right angle to piston pin center line. Measurement must be made at normal temperature (20°C or 68°F).

Piston diameter (STD)

88.44–88.49 mm
(3.4819–3.4839 in)



2. Measure cylinder bore and subtract piston measurement. If clearance exceeds specification, replace piston.

Piston clearance

0.05–0.07 mm (0.0020–0.0028 in)



Crankpin and Bearing

1. Inspect bearings for flaking or scoring. If bearings are damaged, replace.



2. Measure crankpin oil clearance.
 - (1) Clean crankshaft pin, rod, cap and bearing.

Fig. 4-138

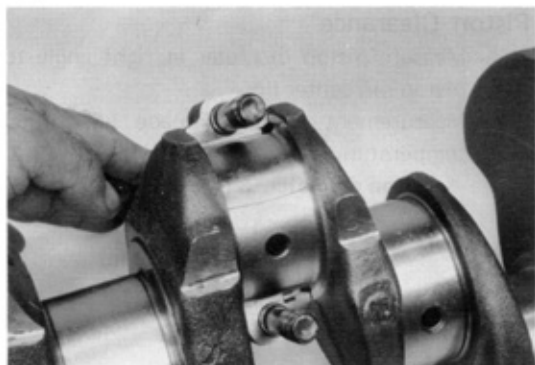

- (2) Lay strip of plastigage across pin.

Fig. 4-139

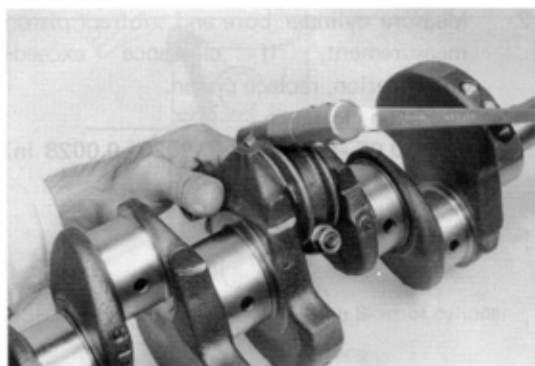

- (3) Tighten cap nuts to specified torque.

Torque

16R, 18R 5.4–6.6 kg-m
(39.1–47.7 ft-lb)

18R-G 6.4–7.0 kg-m
(46.3–50.6 ft-lb)

— Note —

Do not turn connecting rod.

Fig. 4-140

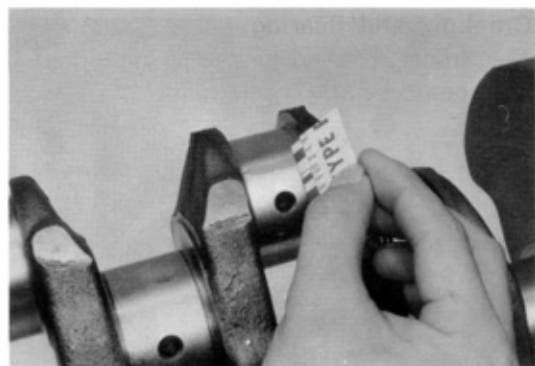

- (4) Measure plastigage at its widest point.

If clearance is not within specification, replace bearings.

Clearance limit

0.08 mm (0.0032 in)

Standard

0.02–0.05 mm

(0.0008–0.0020 in)

U/S Bearing sizes

U/S 0.05, 0.25, 0.50

Fig. 4-141



Assemble piston and rod as follows.

1. Install snap ring on one side.

Fig. 4-142

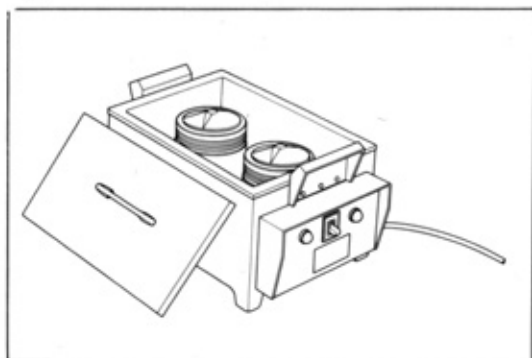

2. Heat piston to about 100° (212°F).

Fig. 4-143



3. Aligning piston notch and rod mark as shown.

Fig. 4-144

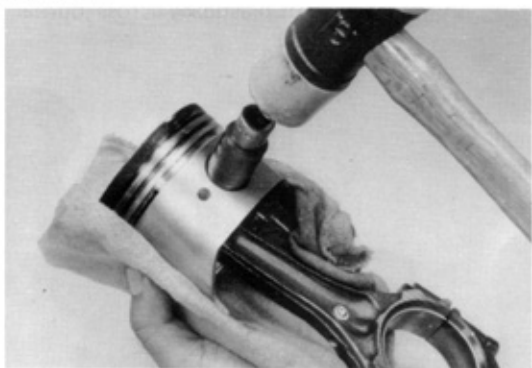

4. Install piston pin.

Fig. 4-145



5. Install snap ring on other side.
Make sure snap ring is completely in place.

Fig. 4-146

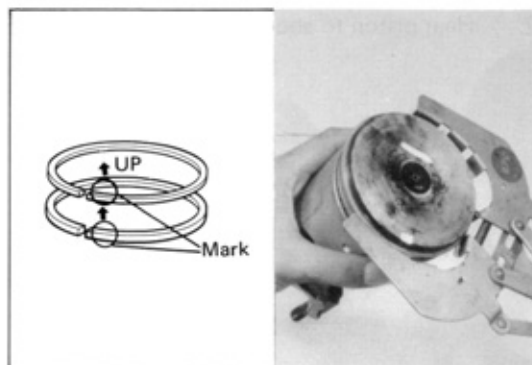

6. Install piston ring, using piston ring expander.
Install two compression rings with code marks facing up.

Fig. 4-147

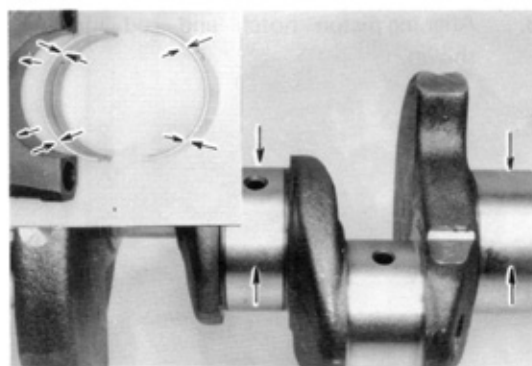

Crankshaft and Bearing

1. Measure crankshaft oil clearance.
 - (1) Clean journal, cap and bearing

Fig. 4-148

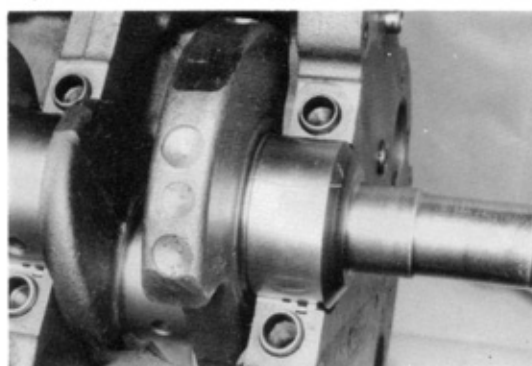

- (2) Lay strip of plastigage across journal.

Fig. 4-149

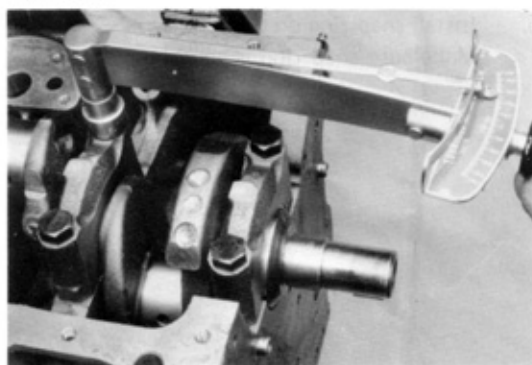

- (3) Tighten cap nuts to specified torque.

| | |
|---------------|-------------------|
| Torque | 16R, 18R |
| | 9.5–11.5 kg-m |
| | (68.7–83.2 ft-lb) |

| | |
|--------------|-----------------------|
| 18R-G | 10.0–11.0 kg-m |
| | (72.3–79.6 ft-lb) |

– Note –

Do not turn crankshaft.

Fig. 4-150

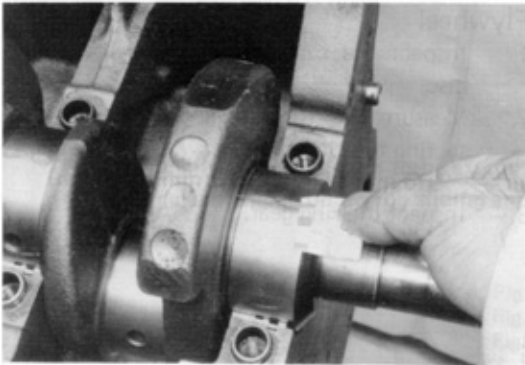

- (4) Measure plastigage at its widest point. If clearance is not within specification, replace bearing.

Clearance limit

0.08 mm (0.0032 in)

Standard

0.02–0.05 mm

(0.0008–0.0020 in)

U/S bearing sizes

U/S 0.05, 0.25, 0.50

Fig. 4-151

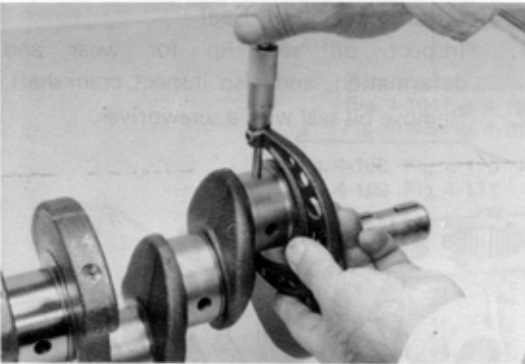

2. Measure crankpin journal. If wear is excessive, crankshaft must be reground or replaced.

Crankpin Journal Size

| | |
|----------|--|
| STD | 52.976–53.000 mm (2.0857–2.0867 in) |
| U/S 0.25 | 52.70–52.71 mm (2.0748–2.0752 in) |
| U/S 0.50 | 52.45–52.46 mm (2.0650–2.0654 in) |

Fig. 4-152

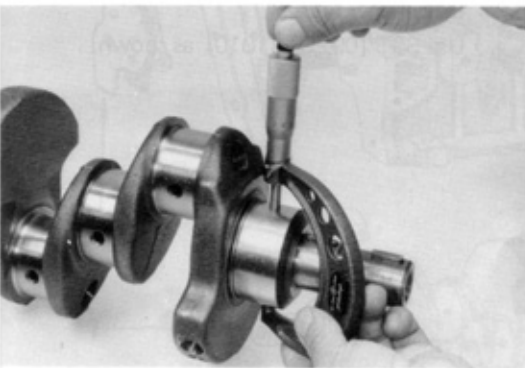

3. Measure crankshaft main journal. If wear is excessive, crankshaft must be reground or replace.

Crankshaft Main Journal Size

| | |
|----------|--|
| STD | 59.976–60.000 mm (2.3613–2.3622 in) |
| U/S 0.25 | 59.70–59.71 mm (2.3504–2.3508 in) |
| U/S 0.50 | 59.45–59.46 mm (2.3406–2.3409 in) |

Fig. 4-153

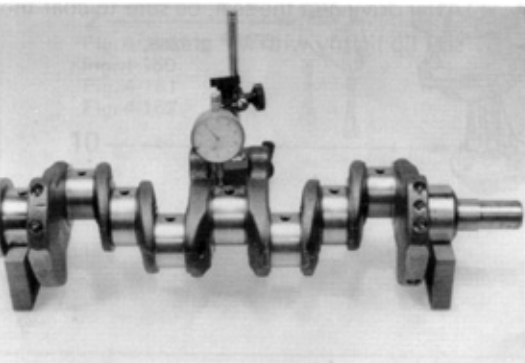

4. Check crankshaft for runout and if it exceeds limit, replace.

Run out limit 0.05 mm (0.0020 in)

Fig. 4-154

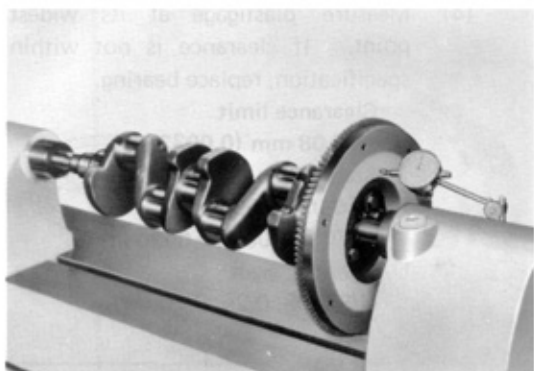

Flywheel

1. Inspect the surface contacting the clutch disc.
2. Measure the runout of the surface contacting the clutch disc.

Runout limit 0.2 mm (0.008 in)

3. Inspect the ring gear.

Fig. 4-155



Crankshaft Rear Oil Seal

1. Inspect oil seal lip for wear and deformation, and also inspect crankshaft.
2. Remove oil seal with a screwdriver.

Fig. 4-156

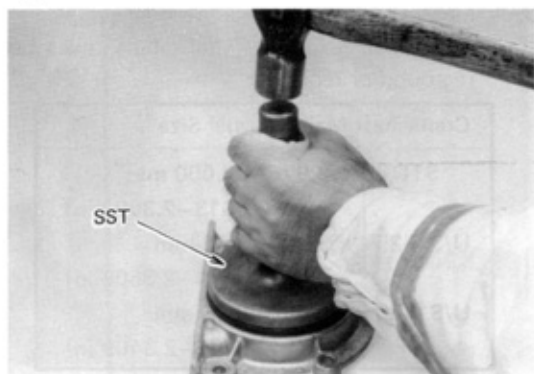

3. Install new oil seal.
Use SST [09223-41010] as shown.

Fig. 4-157

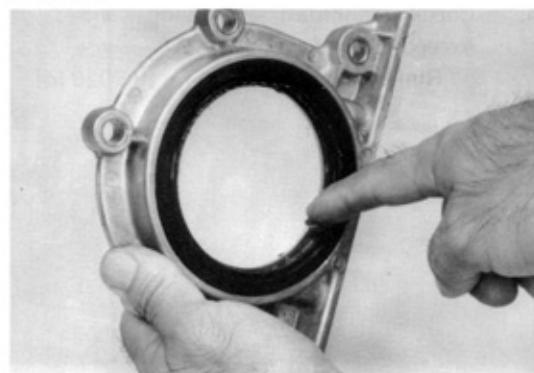

4. After driving in the seal, be sure to coat the seal lip lightly with MP grease.

ASSEMBLY

Assemble in numerical order

Fig. 4-158

- Thoroughly clean the parts to be assembled.
- Apply clean engine oil on the sliding and rotating surfaces of the parts before assembly.

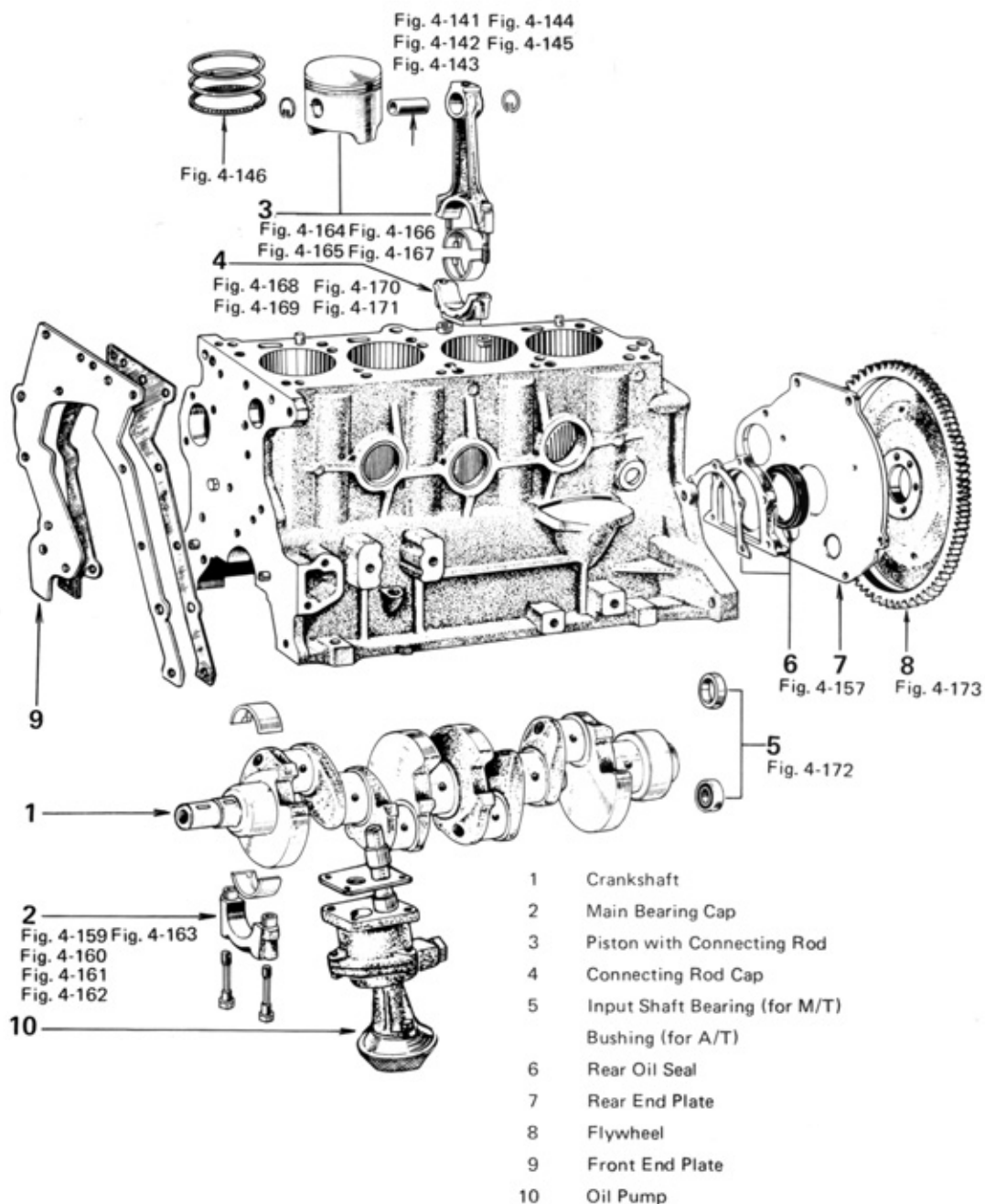
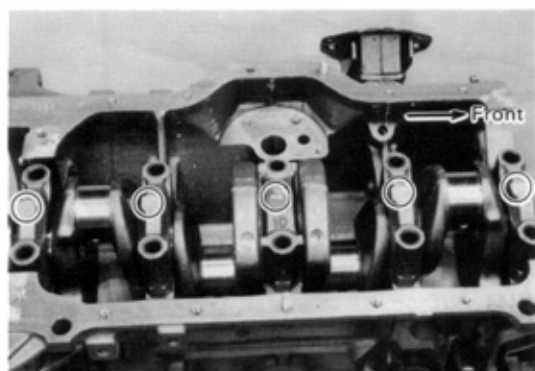
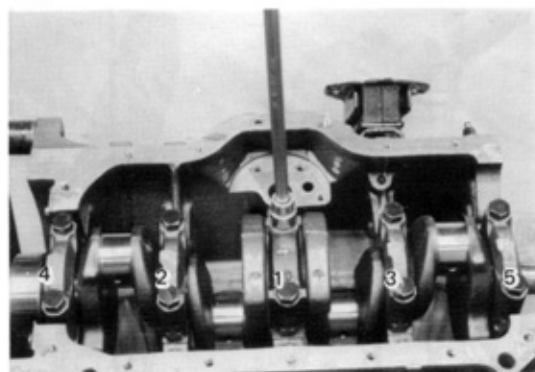

Fig. 4-159



Face the arrow mark toward front.

Fig. 4-160



Gradually tighten bearing cap bolts in 2 to 3 stages as shown.

Fig. 4-161

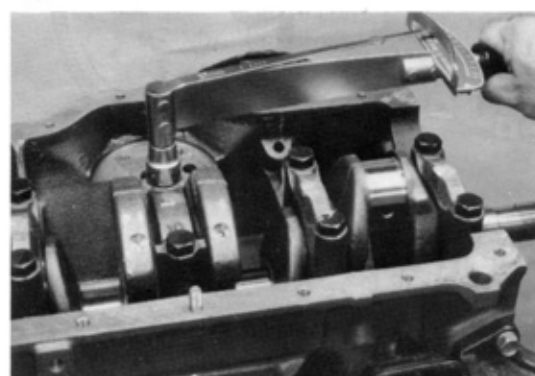

Tighten bearing caps to specified torque.

Torque

| | |
|-----------------|---|
| 16R, 18R | 9.5–11.5 kg-m (68.7–83.2 ft-lb) |
| 18R-G | 10.0–11.0 kg-m (72.3–79.6 ft-lb) |

Fig. 4-162

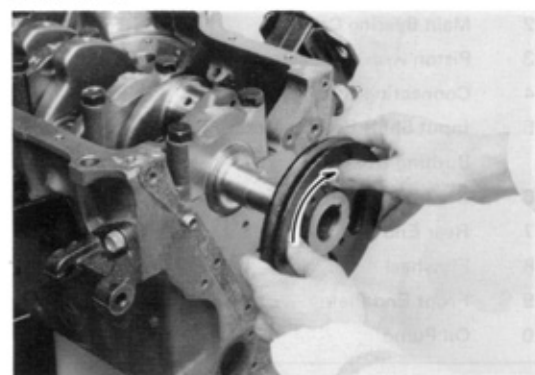

Make sure crankshaft rotates smoothly.

Fig. 4-163

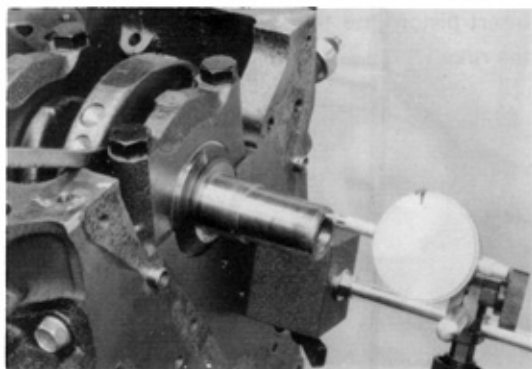

Make sure crankshaft thrust clearance.

Thrust clearance

| | |
|-----------------|---|
| Limit | 0.3 mm (0.0118 in) |
| Standard | 0.002–0.20 mm (0.0008–0.0079 in) |

Fig. 4-164

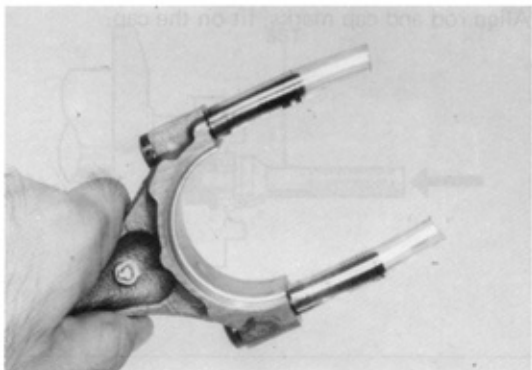

Cover rod bolts with a hose to protect crankpin from damage.

Fig. 4-165

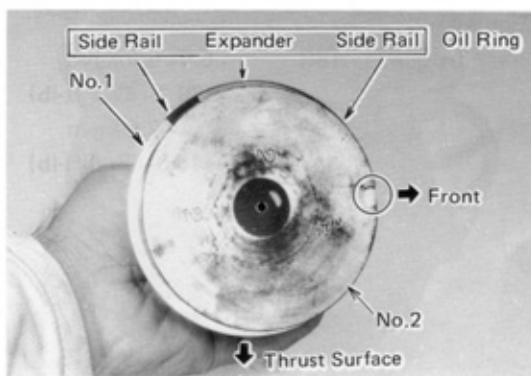

Position ring gap in direction as shown.

Fig. 4-166

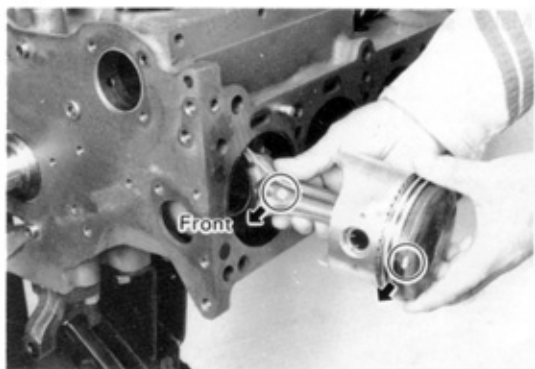

Push correctly numbered piston/rod assembly with notch forward.

Mark on connecting rod should face forward.

Fig. 4-167

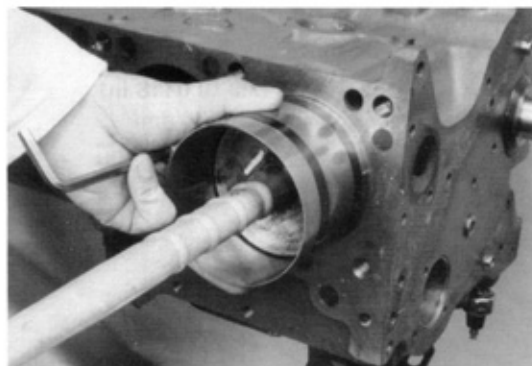

Insert piston into the cylinder while compressing the rings with a piston ring compressor.

Fig. 4-168

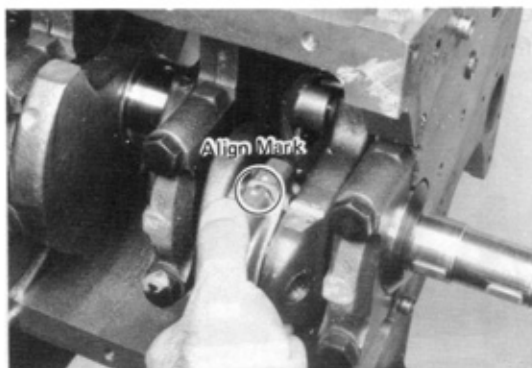

Align rod and cap marks, fit on the cap.

Fig. 4-169

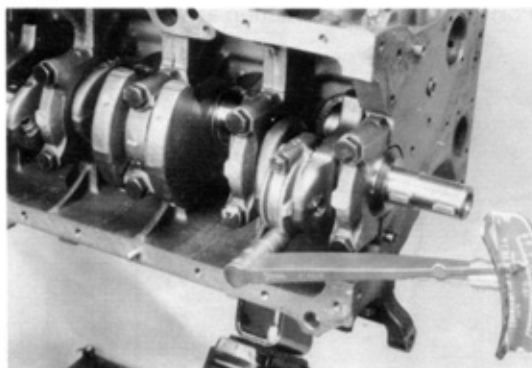

Tighten rod cap to specified torque.

| | | |
|---------------|--------------|---|
| Torque | 18R | 5.4–6.6 kg-m (39.1–47.7 ft-lb) |
| | 18R-G | 6.4–7.0 kg-m (46.3–50.6 ft-lb) |

Fig. 4-170

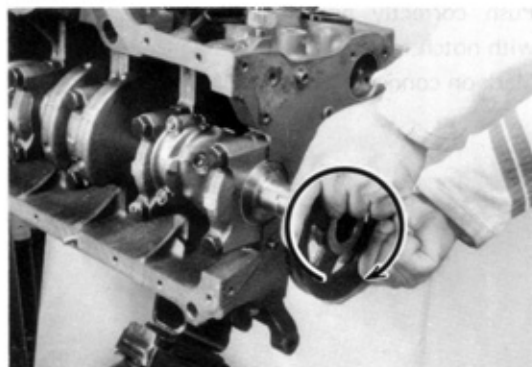

Make sure the crankshaft rotates smoothly.

Fig. 4-171

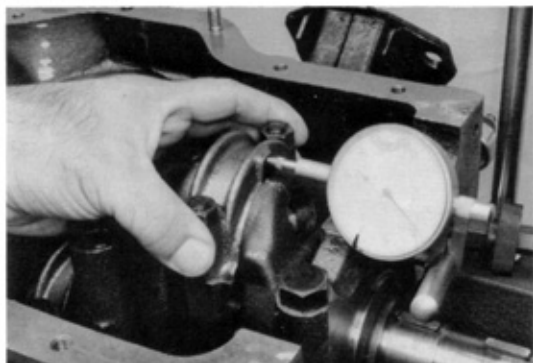

Check connecting rod thrust clearance.

Thrust clearance limit

0.3 mm (0.012 in)

Standard 0.16–0.26 mm

(0.0063–0.0102 in)

Fig. 4-172

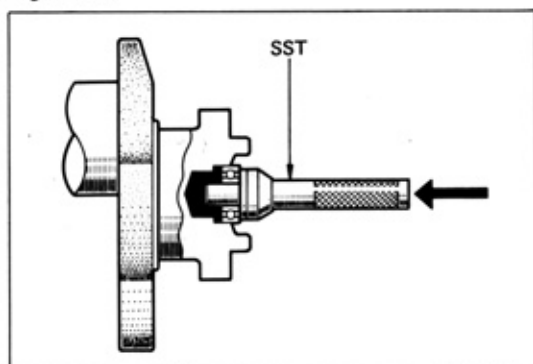

Drive in input shaft bearing.

Use SST [09304-30012].

Fig. 4-173



Tighten flywheel to specified torque.

| | | |
|---------------|------------|---|
| Torque | 18R | 7.0–8.0 kg-m (50.6–57.9 ft-lb) |
|---------------|------------|---|

| | | |
|--|--------------|---|
| | 18R-G | 8.2–8.8 kg-m (59.3–63.7 ft-lb) |
|--|--------------|---|

MEMO
